



1598

LOADER

Published 01/11

Part No. F-4257C

OPERATOR'S MANUAL



This Operator's Manual is an integral part of the safe operation of this machine and must be maintained with the unit at all times. READ, UNDERSTAND, and FOLLOW the Safety and Operation Instructions contained in this manual before operating the equipment. *C01-Cover*



RHINO[®]

1020 S. Sangamon Ave.
Gibson City, IL 60936
800-446-5158
Email: parts@servis-rhino.com

¡ATENCIÓN!
LEA EL INSTRUCTIVO



Si No Lee Ingles, Pida
Ayuda a Alguien
Que Se Lo Lea Para Que le
Traduzca Las
Medidas de Seguridad



To the Owner/Operator/Dealer

All implements with moving parts are potentially hazardous. There is no substitute for a cautious, safe-minded operator who recognizes the potential hazards and follows reasonable safety practices. The manufacturer has designed this implement to be used with all its safety equipment properly attached to minimize the chance of accidents.

BEFORE YOU START! Read the safety messages on the implement and shown in your manual. Observe the rules of safety and common sense!



WARNING

TO AVOID SERIOUS INJURY OR DEATH:

1. READ AND UNDERSTAND OPERATOR'S MANUAL.
2. TRACTOR MUST BE EQUIPPED WITH ROLL-OVER PROTECTION (ROPS) AND SWAY CHAINS.
3. ALWAYS WEAR SAFETY GLASSES, SAFETY SHOES AND SEAT BELT FASTENED TIGHTLY.
4. STOP TRACTOR, LOCK BRAKES, AND BLOCK UP OR SUPPORT IMPLEMENT SECURELY BEFORE WORKING UNDER RAISED COMPONENTS.
5. ALLOW NO RIDERS AT ANY TIME ON TRACTOR OR IMPLEMENT. FALLING OFF CAN KILL.
6. KEEP BYSTANDERS CLEAR OF MOVING PARTS AND WORKING AREA. KEEP CHILDREN AWAY!
7. DO NOT LIFT, LOWER, OR OPERATE UNLESS EVERYONE IS CLEAR OF IMPLEMENT.
8. USE INCREASED CAUTION ON SLOPES & NEAR BANKS AND DITCHES TO PREVENT OVERTURN.
9. LOCK LIFT LEVER UP FOR TRANSPORT. HAVE SMV SIGN VISIBLE. FOLLOW LOCAL LAWS.
10. USE PARKING STAND OR BLOCK UP WHEN UNHITCHING FROM TRACTOR.

999200

WARRANTY INFORMATION:

Read and understand the complete Warranty Statement found in this Manual. Fill out the Warranty Registration Form in full and return it within 30 Days. Make certain the Serial Number of the Machine is recorded on the Warranty Card and on the Warranty Form that you retain.

TABLE OF CONTENTS

SAFETY SECTION	1-1
General Safety Instructions and Practices	1-2
Operator Safety Instructions and Practices	1-4
Equipment Operation Safety Instructions and Practices	1-6
Connecting or Disconnecting Implement Safety Instructions and Practices	1-12
Transporting Safety Instructions and Practices	1-13
Maintenance and Service Safety Instructions and Practices	1-14
Storage and Parking Safety Instructions and Practices	1-16
Concluding Safety Instructions and Practices	1-16
Decal Location	1-17
Decal Description	1-19
Federal Laws and Regulations	1-23
INTRODUCTION SECTION	2-1
ASSEMBLY SECTION	3-1
General Information	3-2
Proper Ballasting and Wheel Spacing	3-4
Assembly Instructions	3-5
Preparing Tractor	3-6
Pallet Component Removal	3-6
Installing Left and Right Midmounting Brackets	3-7
Installing Manual Canister to Boom Assembly	3-7
Installing Grille Guard	3-8
Plumbing Loader	3-9
Mounting Loader to Tractor	3-10
Attaching Bucket to Loader	3-11
Connecting Quick Attach Device (Optional)	3-12
Pre-Operation Check	3-13
Dismounting the Loader	3-14
Mounting Loader	3-15
OPERATION SECTION	4-1
Standard Equipment and Specifications	4-3
Operator Requirements	4-4
Tractor Requirements	4-7
ROPS and Seat Belt	4-7
Tractor Lighting and SMV Emblem	4-7
Tractor Ballast	4-8
Tractor Ballast	4-8
Getting On and Off the Tractor	4-9
Boarding the Tractor	4-9
Dismounting the Tractor	4-9
Starting the Tractor	4-10
Pre-Operation Inspection and Service	4-12
Tractor Pre-Operation Inspection/Service	4-13
Loader Pre-Operation Inspection and Service	4-13
Driving the Tractor and Loader	4-18
Starting the Tractor	4-19

Brake and Differential Lock Setting	4-19
Driving the Tractor and Loader	4-20
Operating the Tractor and Loader	4-20
Operating the Loader	4-25
Operating Bale Spear	4-37
Valve Lock	4-38
Loader Storage	4-39
Transporting the Tractor and Implement	4-40
Transporting on Public Roadways	4-42
Hauling the Tractor and Implement	4-43
Troubleshooting Guide	4-44

MAINTENANCE SECTION 5-1

Lubrication Schedule	5-4
Daily Maintenance	5-5
Storage	5-6
Proper Torque for Fasteners	5-8

SAFETY SECTION

SAFETY

General Safety Instructions and Practices

A careful operator is the best operator. Safety is of primary importance to the manufacturer and should be to the owner/operator. Most accidents can be avoided by being aware of your equipment, your surroundings, and observing certain precautions. The first section of this manual includes a list of Safety Messages that, if followed, will help protect the operator and bystanders from injury or death. Read and understand these Safety Messages before assembling, operating or servicing this Implement. This equipment should only be operated by those persons who have read the manual, who are responsible and trained, and who know how to do so responsibly.



The Safety Alert Symbol combined with a Signal Word, as seen below, is used throughout this manual and on decals which are attached to the equipment. The Safety Alert Symbol means: "ATTENTION! BECOME ALERT! YOUR SAFETY IS INVOLVED!" The Symbol and Signal Word are intended to warn the owner/operator of impending hazards and the degree of possible injury faced when operating this equipment.

Practice all usual and customary safe working precautions and above all---remember safety is up to YOU. Only YOU can prevent serious injury or death from unsafe practices.



Indicates an imminently hazardous situation that, if not avoided, WILL result in DEATH OR VERY SERIOUS INJURY.



Indicates an imminently hazardous situation that, if not avoided, COULD result in DEATH OR SERIOUS INJURY.



Indicates an imminently hazardous situation that, if not avoided, MAY result in MINOR INJURY.



Identifies special instructions or procedures that, if not strictly observed, could result in damage to, or destruction of the machine, attachments or the environment.

NOTE: *Identifies points of particular interest for more efficient and convenient operation or repair.*(SG-1)



Si no lee ingles, pida ayuda a alguien que si lo lea para que le traduzca las medidas de seguridad. (SG-3)

¡ LEA EL INSTRUCTIVO!



Operate this Equipment only with a Tractor equipped with an approved roll-over-protective system (ROPS). Always wear seat belts. Serious injury or even death could result from falling off the tractor--particularly during a turnover when the operator could be pinned under the ROPS. (SG-7)



SAFETY

DANGER

Never allow children to operate, ride on, or come close to the Tractor or Implement. Usually, 16-17 year-old children who are mature and responsible can operate the implement with adult supervision, if they have read and understand the Operator's Manuals, been trained in proper operation of the tractor and Implement, and are physically large enough to reach and operate the controls easily. (SG-11)



DANGER

Never allow children or other persons to ride on the Tractor or Implement. Falling off can result in serious injury or death. (SG-10)



DANGER

Never allow children to play on or around Tractor or Implement. Children can slip or fall off the Equipment and be injured or killed. Inadvertent contact with controls can cause the Implement to shift or fall crushing themselves or others. (SG-25)

DANGER

DO NOT use drugs or alcohol immediately before or while operating the Tractor and Implement. Drugs and alcohol will affect an operator's alertness and coordination and therefore affect the operator's ability to operate the equipment safely. Before operating the Tractor or Implement, an operator on prescription or over-the-counter medication must consult a medical professional regarding any side effects of the medication that would hinder their ability to operate the Equipment safely. NEVER knowingly allow anyone to operate this equipment when their alertness or coordination is impaired. Serious injury or death to the operator or others could result if the operator is under the influence of drugs or alcohol. (SG-27)



WARNING

Engine Exhaust, some of its constituents, and certain vehicle components contain or emit chemicals known to the state of California to cause cancer and birth defects or other reproductive harm. (SG-30)

DANGER

Never walk or work under any raised boom or bucket. The Boom could fall and cause serious bodily injury or death. Always lower the boom and bucket flat on the ground or support the Boom and bucket on safety stands. Unload all hydraulic actuators prior to performing any maintenance. To do this, set the bucket on the ground then kill the tractor engine. Push and pull the control levers in and out several times to remove pressure. Do not work under raised Boom or Bucket unless components are securely blocked up to prevent inadvertent dropping. (SBH-7)

SAFETY

SAFETY

Operator Safety Instructions and Practices



Never operate the Tractor or Implement until you have read and completely understand this Manual, the Tractor Operator's Manual, and each of the Safety Messages found in the Manual or on the Tractor and Implement. Learn how to stop the tractor engine suddenly in an emergency. Never allow inexperienced or untrained personnel to operate the Tractor or Implement without supervision. Make sure the operator has fully read and understood the manuals prior to operation. (SG-4)



The operator and all support personnel should wear hard hats, safety shoes, safety glasses, and proper hearing protection at all times for protection from injury including injury from items that may be thrown by the equipment. (SG-16)

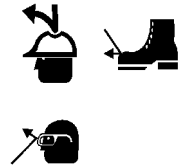

PROLONGED EXPOSURE TO LOUD NOISE MAY CAUSE PERMANENT HEARING LOSS! Tractors with or without an Implement attached can often be noisy enough to cause permanent hearing loss. We recommend that you always wear hearing protection if the noise in the Operator's position exceeds 80db. Noise over 85db over an extended period of time will cause severe hearing loss. Noise over 90db adjacent to the Operator over an extended period of time will cause permanent or total hearing loss. **NOTE:** *Hearing loss from loud noise [from tractors, chain saws, radios, and other such sources close to the ear] is cumulative over a lifetime without hope of natural recovery.* (SG-17)



Always read carefully and comply fully with the manufacturer's instructions when handling oil, solvents, cleansers, and any other chemical agent. (SG-22)



Never run the Tractor engine in a closed building or without adequate ventilation. The exhaust fumes can be hazardous to your health. (SG-23)



Battery posts, terminals and related accessories contain lead and lead compounds, chemicals known to the state of California to cause cancer, birth defects or other reproductive harm. (SG-31)

SAFETY

WARNING

Prolonged operation may cause operator boredom and fatigue affecting safe operation. Take scheduled work breaks to help prevent these potentially impaired operating conditions. Never operate the Implement and Tractor in a fatigued or bored mental state which impairs proper and safe operation. (SG-32)

WARNING

Use extreme caution when getting onto the Implement to perform repairs, maintenance and when removing accumulated material. Only stand on solid flat surfaces to ensure good footing. Use a ladder or raised stand to access high spots which cannot be reached from ground level. Slipping and falling can cause serious injury or death. (SG-33)

WARNING

Use extreme care when loading, carrying or handling any agricultural fertilizers, chemicals or biological residue. Follow the manufacturer's handling instructions and wear appropriate Personal Protective Equipment including gloves, safety glasses and respirator when required. If you are using a tractor equipped with a cab, make sure the cab is rated for appropriate environmental exposure. Be safe and always wear proper protection. Short or long term exposure to certain chemicals and materials can result in serious injury or death. (SL-19)



WARNING

Repeated or substantial breathing of hazardous dusts, including crystalline silica, could cause fatal or serious respiratory disease including silicosis. Concrete, masonry, many types of rock, and various other materials contain silica sand. California lists respirable crystalline silica as a substance known to cause cancer. Operation of this equipment under certain conditions may generate airborne dust particles that could contain crystalline silica. In those conditions, personal protective equipment including an appropriate respirator must be used. If excessive dust is generated, a dust collection or suppression system should also be used during operation. (SG-41)

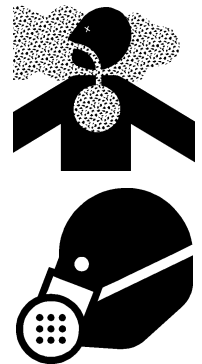

SAFETY

SAFETY

Equipment Operation Safety Instructions and Practices



This Implement may be wider than the Tractor. Be careful when operating or transporting this equipment to prevent the Implement from running into or striking sign posts, guard rails, concrete abutments or other solid objects. Such an impact could cause the Implement and Tractor to pivot violently resulting in loss of steering control, serious injury, or even death. Never allow the Implement to contact obstacles. (S3PT-12)



Never grasp control levers when mounting the machine. (SBH-4)



The Boom is designed only to position and operate the Bucket which is attached to it. Never attempt to lift, pull, or push other solid objects with the boom or bucket. Serious injury could result from a structural failure when the Boom is used for purposes other than those for which it was designed. (SBH-9)



BEFORE leaving the tractor seat lower the implement, set the parking brake and/or set the tractor transmission in parking gear, disengage the PTO, stop the engine, remove the key, and wait for all moving parts to stop. Place the tractor shift lever into a low range or parking gear to prevent the tractor from rolling. Never dismount a Tractor that is moving or while the engine is running. Operate the Tractor controls from the tractor seat only. (SG-9)

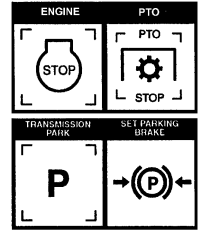

Do not mount or dismount the Tractor while the tractor is moving. Mount the Tractor only when the Tractor and all moving parts are completely stopped. (SG-12)



Start tractor only when properly seated in the Tractor seat. Starting a tractor in gear can result in injury or death. Read the Tractor operators manual for proper starting instructions. (SG-13)



Operate the Tractor and/or Implement controls only while properly seated in the Tractor seat with the seat belt securely fastened around you. Inadvertent movement of the Tractor or Implement may cause serious injury or death. (SG-29)

SAFETY



DO NOT operate this Implement on a Tractor that is not properly maintained. Should a mechanical or Tractor control failure occur while operating, immediately shut down the Tractor and perform repairs before resuming operation. Serious injury and possible death could occur from not maintaining this Implement and Tractor in good operating condition. (SG-36)



Do Not operate this equipment in areas where insects such as bees may attack you and/or cause you to lose control of the equipment. If you must enter in such areas, use a tractor with an enclosed Cab and close the windows to prevent insects from entering. If a tractor cab is not available, wear suitable clothing including head, face, and hand protection to shield you from the insects. Attacking insects can cause you to lose control of the tractor, which can result in serious injury or death to you or bystanders. Never dismount a moving tractor. (SG-40)



Keep bystanders 10 feet away from the tractor and loader while operating. The bystanders could enter the path of the tractor or items could fall from the loader resulting in serious injury to the bystander. (SL-01)

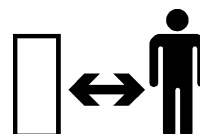

For added safety when lifting loads above the height of the operator, install a certified Falling Object Protective Structure. Shiftable loads, round bales, large loose items, and loader attachments can fall toward the operator resulting in serious injury or death. Falling Object Protective Structure (FOPS) rated Cab may be obtained from the tractor dealer or other sources. (SL-02)



Before dismounting the tractor and loader lower the loader to the ground or onto solid support blocks. Engage the loader valve travel lock to prevent inadvertent movement of the valve controls causing the loader to suddenly move and drop. Sudden dropping of the loader and attachment could result in serious injury. (SL-05)

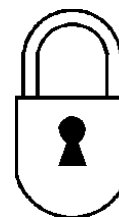

Use extra care when turning or stopping. Allow for increased length and weight of added loader. The loader adds five to six feet of length in front of the tractor and significant weight. Allow extra distance when stopping or turning. Do not allow loader or attachment to contact solid objects. (SL-07)



Do not raise the loader into an overhead structure or allow a raised attachment to contact overhead structures. Sudden or unexpected contact with an overhead structure could result in serious injury. (SL-08)

SAFETY

SAFETY

⚠ DANGER

Do not let the loader or attachment contact electrical power lines. Contact with electrical power lines can result in serious injury or electrocution. If the loader attachment contacts a power line remain in the tractor seat until the power has been shut off. Stepping off the tractor can permit electrical current to pass through the body resulting in electrocution. (SL-09)



⚠ WARNING

Store the grapple bucket or bale spear attachment with the point(s) on the ground. Walking into the point of the bale or grapple spear can cause serious bodily injury. Never drive the bale spear or grapple bucket attachment forward if a bystander is in front of the loader. (SL-10)

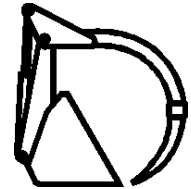

⚠ WARNING

Only mount the loader on a tractor that is listed on the mounting instructions. Never mount on a tricycle steering front axle. Move the tractor front and rear wheels to the widest spacing and add the recommended rear tractor ballast to prevent tractor tip over. Keep the tractor tires properly inflated. Maintain at least 25% of the total Tractor and Loader weight including the maximum load in the bucket or attachment on the rear axle. Always wear your seatbelt and make sure the ROPS structure is fully deployed to prevent serious injury or death from the tractor tipping over. (SL-11)

⚠ WARNING

Carry the loader and attachment low when transporting to reduce the potential of the tractor tipping over. Transport on slopes only at slow speeds and use gradual turning angles. Tractor wheel contact with any wash out, drop off or ground obstruction with a raised loader could result in the tractor tipping over and causing serious injury. (SL-12)



⚠ DANGER

Do not work from the loader or attachments. Do not allow any riders on the loader, tractor or attachments. Falling off the loader could result in serious injury and/or tractor run over. (SL-14)



SAFETY

WARNING

Do not use an attachment that is not securely attached to the quick hitch. The attachment could fall resulting in severe crushing injuries or death to the operator or bystanders.

- Rotate both hitch pin levers down to the locked position. You should feel a firm resistance when locking the levers down. The pins must extend through the slots in the bottom of the attachment bracket.
- Examine the fit between the quick hitch and the bottom of the attachment bracket. The pins must extend through the slots in the bottom of the attachment bracket. The tapered side of each pin must be firmly wedged against the surface of the slot on the bottom of the attachment bracket. The attachment bucket should fit snugly against the bottom of the quick hitch bracket. If there is a gap of more than 1/8" or if the pins are not firmly seated do not use the attachment. Contact your dealer before using the attachment.
- On level ground, tilt the attachment down 90° degrees and lower it to the ground. Lower the loader further to slightly raise the front of the tractor off the ground. Drive the tractor in reverse while the attachment is on the ground for 20-30 feet to ensure the attachment does not disconnect. If the attachment disconnects during this process, discontinue the use of the attachment and contact your dealer.

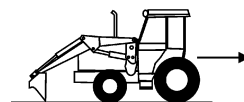
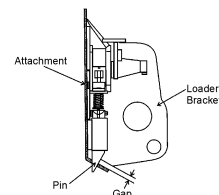
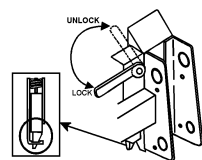

WARNING

NEVER walk or work under or allow any person to be underneath a raised loader or attachment. (SL-15)



WARNING

Do not operate the loader from the ground. Operate the tractor and loader only while seated in the tractor seat with the seatbelt fastened. The loader could fall crushing a person resulting in serious injury or death. (SL-16)

WARNING

Use extreme care when piling material above 6 feet high. Material could shift and fall onto the operator or bystanders. The material could crush or suffocate the operator or bystander resulting in serious injury or death. (SL-17)



SAFETY

SAFETY

WARNING

Know before you DIG. Call 888-258-0808 and request that all buried utilities locations be identified before digging in unfamiliar ground. Do not let the loader or attachment contact buried electrical power lines, utilities or gas lines. Contact with electrical power lines can result in serious bodily injury or electrocution. If the loader contacts a power line, remain in the tractor seat until the power has been shut off. Stepping off the tractor can permit electrical current to pass through the body resulting in electrocution. (SL-18)

DANGER

Do not use loader as a jack to raise the tractor tires off the ground. The loader could fail causing the tractor and loader to fall to the ground resulting in serious injury. (SL-25)

WARNING

Use extreme care when loading, transporting or dumping loads that impair or partially block the operator's line of sight. Know where you are traveling. Make sure no bystanders are in the area of travel. If a bystander assists in providing guidance, make sure they are not in the path of travel. Keep all bystanders 25 feet away from travel path. (SL-29)

WARNING

Always look behind you before backing up. Make sure you are looking in the direction of travel. A bystander could walk behind the tractor. Running into a bystander can result in serious injury or death. (SL-30)



WARNING

Some tractors are equipped with a "Super Steer" front axle. When a loader is mounted to this type of tractor, the bucket will shift in the opposite direction from which the wheels are turned. Maximum shift will be approximately 8 inches and most noticeable when the tractor is stationary. Sudden or unexpected movement of the loader and attachment could result in serious injury to the operator or bystanders. (SL-33)

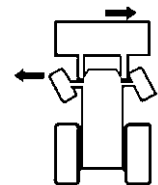

WARNING

Operate the tractor and loader only in conditions where you have clear visibility in daylight or with adequate artificial lighting. Never operate in darkness or foggy conditions where you cannot clearly see at least 100 feet in front and to the sides of the tractor. Make sure you can clearly see bystanders, ditches, steep slopes, drop-offs, overhead obstructions, power lines, and debris or obstruction in the travel path. If you are unable to clearly see these types of items discontinue operating. Contact with unseen vehicles, bystanders, obstructions, or drop-offs can cause serious injury. (SL-35)

DANGER

Be particularly careful in transport. The Implement has raised and moved the center of gravity to the front of the Power Unit increasing the possibility of overturn and tipping forward. Turn curves or go up slopes only at low speed and using a gradual turning angle. Go up slopes with the Implement located uphill. Slow down on rough or uneven surfaces. (SPU-2)

SAFETY

WARNING

Never leave the Implement and Power Unit unattended while the Implement is in the raised position. Accidental operation of a lifting lever or a hydraulic failure may cause the implement to suddenly fall causing serious injury or possible death to anyone who might inadvertently be under the Implement. Lower the implement carefully to the ground. Do not put hands or feet under lifted components. (SPU-3)

DANGER

The center of gravity of a Power Unit equipped with a front-mounted Implement is shifted to the front and removes weight from the rear wheels. The Power Unit should maintain at least 25% total weight with the maximum load in the bucket or attachment on the rear wheels to prevent tipping forward, loss of steering control, and possible injury. Add counterweight if required when operating on slopes and proceed with the load uphill to prevent tipping. Reference the Power Unit's Operator's Manual or an authorized dealer for information on adding additional weight. (SL-37)

WARNING

Your driving vision may be reduced or impaired by the tractor, cab, or implement. Before driving on public roadways identify any limited vision areas, and make adjustments to your operating position, mirrors, and the implement transport position so that you can clearly see the area where you will be traveling, and any traffic that may approach you. Failure to maintain adequate vision of the public roadway and traffic can result in serious injury or even death. (STI-10)

WARNING

Make sure the hydraulic quick disconnects are fully seated into the connections. Do not use the loader if the hydraulic connection is leaking. Leaking oil could allow the loader to fall resulting in a serious crushing injury. (SL-22)

WARNING

If the loader valve controls fail to function properly discontinue use of the tractor and loader until the controls are properly repaired. Sudden or unexpected movement or dropping of the loader and attachment could result in serious injury. (SL-31)

CAUTION

Make sure all air is purged from the hydraulic system before using the loader. Air in the system can cause the loader to respond sluggishly or with unexpected movement. The air can be purged from the cylinder lines by fully cycling the cylinders several times from the fully closed to fully open position. Sudden or unexpected movement or dropping of the loader and attachment could result in serious injury. (SL-32)

SAFETY

Connecting or Disconnecting Implement Safety Instructions and Practices

⚠ WARNING

Do not stand or allow bystander or coworkers between the loader and the tractor while installing or disconnecting the loader from the tractor. Keep hands and body clear of the loader and the loader mounts. Serious injury or death can result from a person being crushed between the tractor and loader. (SL-03)

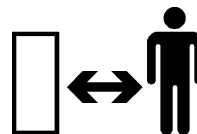

⚠ DANGER

Never allow anyone to get under the loader or attachment or to reach through the loader lift arms when raised. Serious injury could result from crushing or pinching by the loader or attachment. (SL-06)



⚠ WARNING

Make sure the loader is properly attached to the tractor and the retaining pins securely lock the loader into position. Improper mounting of the loader onto the tractor can result in the loader falling causing serious injury. (SL-23)

⚠ WARNING

Make sure all tractor and loader guards are in place and properly functioning. Do not use an attachment if the roll back guards are damaged or missing. The roll back guards prevents items carried in the attachment from rolling back onto the operator causing serious injury. For added safety when lifting loads above the height of the operator, install a certified Falling Object Protective Structure. (SL-28)

SAFETY

Transporting Safety Instructions and Practices



WARNING Transport only at speeds where you can maintain control of the equipment. Serious accidents and injuries can result from operating this equipment at high speeds. Understand the Tractor and Implement and how it handles before transporting on streets and highways. Make sure the Tractor steering and brakes are in good condition and operate properly.



Before transporting the Tractor and Implement, determine the proper transport speeds for you and the equipment. Make sure you abide by the following rules:

Test the tractor at a slow speed and increase the speed slowly. Apply the Brakes smoothly to determine the stopping characteristics of the Tractor and Implement. As you increase the speed of the Tractor the stopping distance increases. Determine the maximum transport speed not to exceed 20 mph (30 kph) for transporting this equipment.

Test the equipment at a slow speed in turns. Increase the speed through the turn only after you determine that the equipment can be operated at a higher speed. Use extreme care and reduce your speed when turning sharply to prevent the tractor and implement from turning over. Determine the maximum turning speed for you and this equipment before operating on roads or uneven ground.

Only transport the Tractor and Implement at the speeds which allow you to properly control the equipment.

Be aware of the operating conditions. Do not operate the Tractor with weak or faulty brakes or worn tires. When operating down a hill or on wet or rain slick roads, the braking distance increases: use extreme care and reduce your speed. When operating in traffic always use the Tractor's flashing warning lights and reduce your speed. Be aware of traffic around you and watch out for the other guy. (SG-19)



WARNING Before transporting the tractor and Loader engage the loader valve travel lock to prevent inadvertent contact with the joystick controller causing sudden dropping of the loader and attachment. If the loader attachment, such as a bucket, were to drop suddenly and hit the ground while transporting, the tractor could stop immediately resulting in the operator hitting the steering wheel or flying out of the operator's seat. Serious injury could result. (SL-04)



DANGER Do not raise the loader on a hillside. Do not transport across a slope with a raised loader. When the loader is raised, the center of gravity of the tractor and loader is raised increasing the potential for the tractor to tip over. Tractor wheel contact with any wash out, drop off or the ground obstruction with a raised loader could result in the tractor tipping over and causing serious bodily injury. (SL-21)



SAFETY

SAFETY



Lower the loader to the bed of the truck or trailer when transporting the tractor and loader with a truck. Measure to ensure the transport height does not exceed the legal limits. Contact with overhead obstructions or power lines can cause property damage or serious injury. (SL-34)

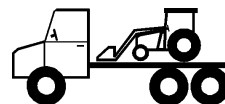

In case of mechanical difficulty during operation, place the transmission in the park position, set the parking brake, shut down all power, including the PTO and the engine and remove the key. Wait until all rotating motion has stopped before dismounting. (SG-39)



Transport an empty bale spear tilted back in the vertical position to prevent unintended harm to a person, animal or object. Serious injury or death may occur from a bale spear puncture. (SL-39)

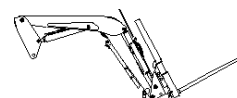

Never drive the power unit with the bucket or plow in the raised position. Traveling with the bucket or plow in the raised position increases the chances of colliding with overhead obstructions and making the unit more prone to tipping over. (SNPO-37)

Maintenance and Service Safety Instructions and Practices



Never interfere with factory-set hydraulic calibrations. Any change in calibration could cause a failure of the equipment and may result in injury. (SBH-13)

READ, UNDERSTAND, and FOLLOW the following Safety Messages. Serious injury or death may occur unless care is taken to follow the warnings and instructions stated in the Safety Messages. Always use good common sense to avoid hazards. (SG-2)



Always maintain the safety signs in good readable condition. If the safety signs are missing, damaged, or unreadable, obtain and install replacement safety signs immediately. (SG-5)



Make certain that the "Slow Moving Vehicle" (SMV) sign is installed in such a way as to be clearly visible and legible. When transporting the Equipment use the Tractor flashing warning lights and follow all local traffic regulations. (SG-6)

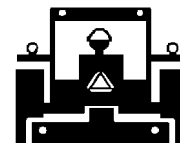

Do not modify or alter this Implement. Do not permit anyone to modify or alter this Implement, any of its components or any Implement function. (SG-8)

SAFETY

⚠ DANGER

Never work under the Implement, the framework, or any lifted component unless the Implement is securely supported or blocked up to prevent sudden or inadvertent falling which could cause serious injury or even death. (SL-36)



⚠ WARNING

Do not operate this Equipment with hydraulic oil or fuel leaking. Oil and fuel are explosive and their presence could present a hazard. Do not check for leaks with your hand! High-pressure oil streams from breaks in the line could penetrate the skin and cause tissue damage including gangrene. To check for a hose leak, SHUT the unit ENGINE OFF and remove all hydraulic pressure. Wear oil impenetrable gloves, safety glasses and use Cardboard to check for evidence of oil leaks. If you suspect a leak, REMOVE the HOSE and have it tested at a Dealer. If oil does penetrate the skin, have the injury treated immediately by a physician knowledgeable and skilled in this procedure. (SG-15)



⚠ WARNING

Never attempt to lubricate, adjust, or remove material from the Implement while it is in motion or while tractor engine is running. (SG-20)

⚠ WARNING

Periodically inspect all moving parts for wear and replace when necessary with authorized service parts. Look for loose fasteners, worn or broken parts, and leaky or loose fittings. Make sure all pins have cotter pins and washers. Serious injury may occur from not maintaining this machine in good working order. (SG-21)

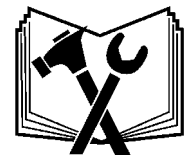

⚠ DANGER

Do Not fill fuel tank while engine is running. Refuel only after engine has cooled down. If fuel is spilled, move machine away from the area of the spill and avoid creating any source of ignition until the fuel has evaporated. (SBH-49)

⚠ WARNING

Avoid contact with hot surfaces including hydraulic oil tanks, pumps, motors, valves and hose connections. Relieve hydraulic pressure before performing maintenance or repairs. Use gloves and eye protection when servicing hot components. Contact with a hot surface or fluid can cause serious injury from burns or scalding. (SG-34)

⚠ WARNING

Use caution and wear protective gloves when handling sharp objects such as blades, knives, and other cutting edges. Be alert to worn component surfaces which have sharp edges. Sharp surfaces can inflict severe laceration injuries if proper hand protection is not worn. (SG-37)

SAFETY



WARNING

Avoid contact with hot surfaces of the engine or muffler. Use gloves and eye protection when servicing hot components. Contact with a hot surface or fluid can cause serious injury from burns or scalding. (SG-38)



DANGER

Never allow anyone to get under the loader or attachment or to reach through the loader lift arms when raised. Serious injury could result from crushing or pinching by the loader or attachment. (SL-06)



PARTS INFORMATION

Rhino products are designed utilizing specifically matched system components to ensure optimum equipment performance. These parts are made and tested to Rhino specifications. Non-genuine "will fit" parts do not consistently meet these specifications. The use of "will fit" parts may reduce equipment performance, void warranties, and present a safety hazard. Use genuine Rhino parts for economy and safety. (SPRM-2)

SEE YOUR RHINO DEALER

SAFETY

Storage and Parking Safety Instructions and Practices



DANGER

Never crawl under or allow children to play around or on a loader that is disconnected from the tractor. The loader could fall crushing a person resulting in serious injury or death. (SL-13)



WARNING

Do not remove the attachment from the loader when the loader is disconnected from the tractor. The attachment stabilizes the loader. If the attachment is removed, the loader will fall and could result in serious injury. (SL-26)



WARNING

Only disconnect and store the loader on firm flat ground. Make sure the loader stands are properly installed and rest on firm ground or support blocks. If the stands sink or fail, the loader could fall causing serious injury. (SL-27)

Concluding Safety Instructions and Practices

In addition to the design and configuration of this Implement, including Safety Signs and Safety Equipment, hazard control and accident prevention are dependent upon the awareness, concern, prudence, and proper training of personnel involved in the operation, transport, maintenance, and storage of the machine. Refer also to Safety Messages and operation instruction in each of the appropriate sections of the Tractor and Equipment Manuals. Pay close attention to the Safety Signs affixed to the Tractor and Equipment. (SG-18)

SAFETY

SAFETY

Decal Location

NOTE: Rhino supplies safety decals on this product to promote safe operation. Damage to the decals may occur while in shipping, use, or reconditioning. Rhino cares about the safety of its customers, operators, and bystanders, and will replace the safety decals on this product in the field, free of charge (Some shipping and handling charges may apply). Contact your Rhino dealer to order replacement decals.

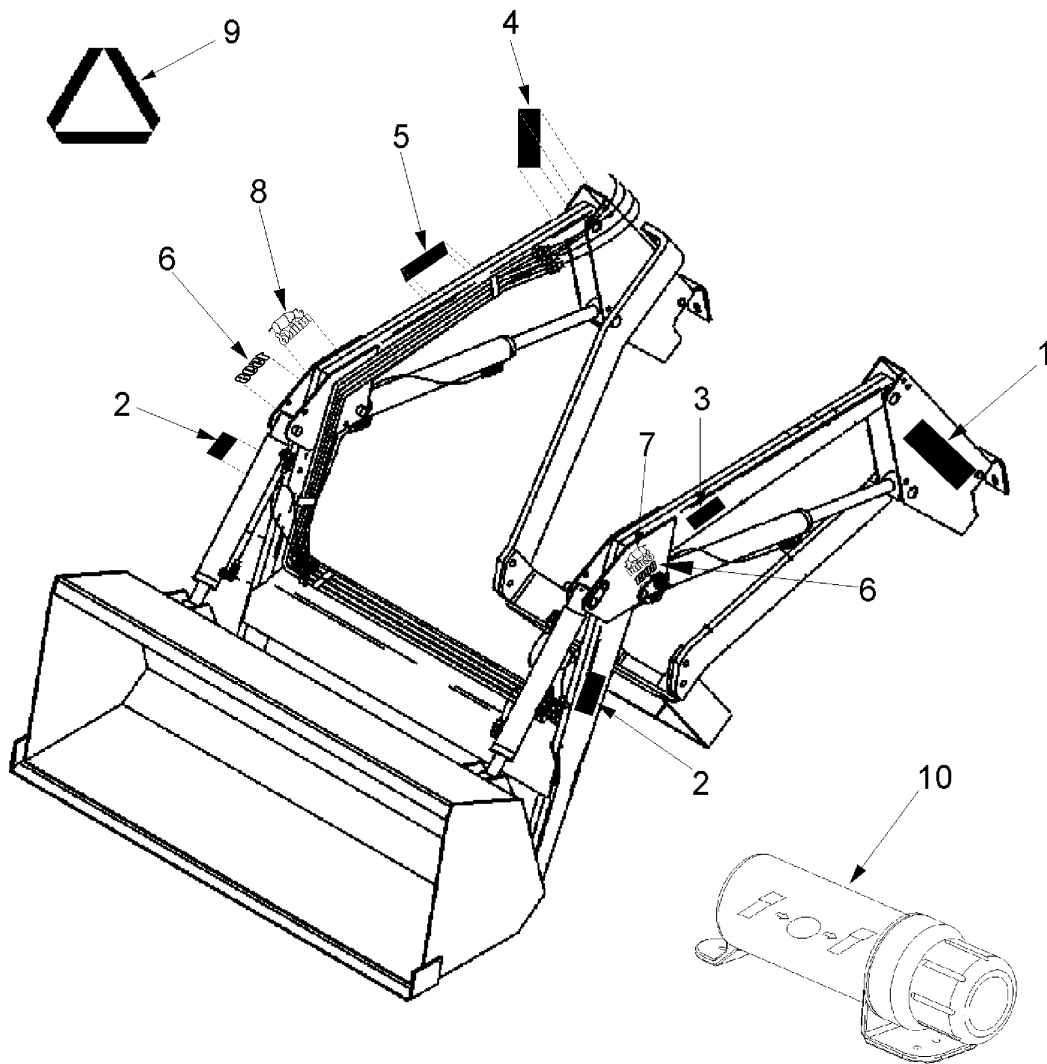

SAFETY

SAFETY

ITEM	PART NO.	QTY	LEVEL	DESCRIPTION
1.	D469	1	WARNING	Loader Safety
2.	D468	2	DANGER	Crushing, Electrocutation, Falling Hazard
3.	D471	1	WARNING	Handling Bales
4.	52740	1	WARNING	Oil Leaks
5.	D470	1	DANGER	Use ROPS, Seatbelt, Rear Ballast
6.	54474	2	MODEL	1598
7.	49696	1	LOGO	Rhino, Left
8.	51448	1	LOGO	Rhino, Right
9.	03200347	*	REFLCTR	SMV Sign
10.	00776031	1	_____	Canister, Operator's Manual
11.	55580	1	_____	Sheet, Decal; includes two D516 Decals (Note: For Optional Quick Attach Device Only)

* Provided by Tractor Manufacturer. Replace if missing from Tractor.

NOTE: Order D438 Safety Decal Sheet which includes all safety decals.

SAFETY

SAFETY

Decal Description

Loader Safety

- Read, understand and follow the operation, warning, and safety instructions in the Operator's Manual.
- Equip tractor with ROPS (Roll Over Protection System) before installing or operating the loader.
- Operate Loader only from operator's seat with the seatbelt securely fastened around you.
- Carry bucket low during transport for better visibility and to avoid overturns.
- Keep bystanders 10 feet away when operating loader.
- When parking or servicing unit, lower bucket to the ground on level hard surface, stop engine, set parking brake, place transmission in park.
- Read and understand mounting instructions in the operator's manual before installing or detaching loader.
- Do not remove bucket or attachment from detached loader.
- Do not allow riders on tractor or loader.
- Do not allow children or untrained persons to operate loader.



D469

Crushing Hazard, Electrocutation Hazard, Falling Hazard.

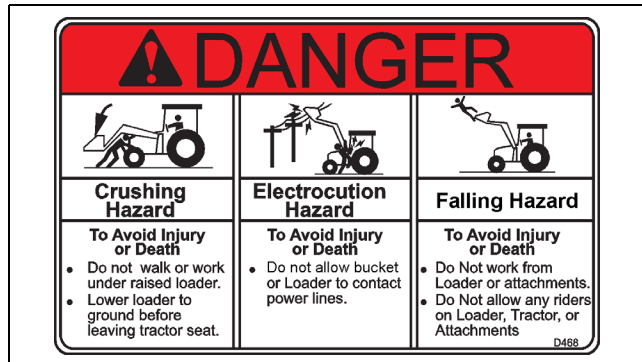

D468

Crushing Hazard

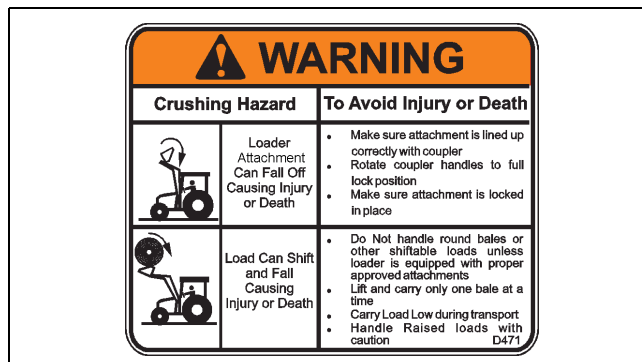

D471

SAFETY

SAFETY

WARNING! - DO NOT operate with oil leaks.

-Inspect hoses regularly. Failure to inspect and replace worn hoses may allow them to rupture suddenly and violently, resulting in serious bodily injury or death from scalding, fire burn injury, or oil penetration.

-Frayed, torn or crimped hoses may rupture and spray hot oil on operator causing serious injury. Oil may spray on hot tractor parts and catch fire resulting in severe injury, burn or death.

-To check for hose leak, shut tractor off and remove hydraulic pressure. Never use hands to check for leaks.

-Wear safety glasses, oil, impenetrable gloves, and use cardboard to check for evidence of oil leaks. If you suspect a leak, remove the hose and have it tested at a dealer.

KEEP SHIELDS IN PLACE OVER HYDRAULIC COMPONENTS. Do not operate equipment if shields are missing or if oil leaks exist.

-Repair or replace hoses as needed to prevent unexpected failure and possible serious injury to operator or bystander. If oil penetrates skin, serious injury or gangrene could occur. A doctor familiar with this type of injury must surgically remove the injected fluid immediately.

P/N 52740



DANGER! - Use ROPS and seatbelt at all times. Add recommended rear ballast. Operate tractor at low speeds. Failure to comply may result in serious injury or death.

D470



NAME - 1598

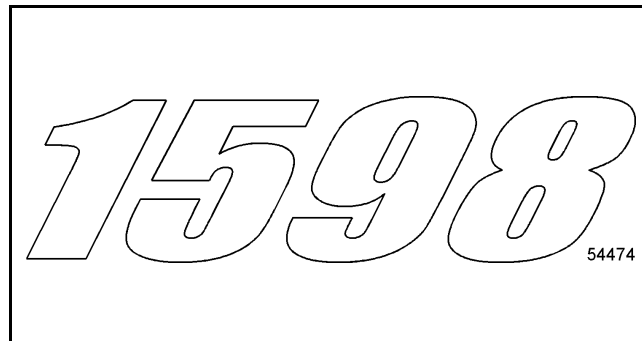

P/N 54474

SAFETY

Rhino, Left

P/N 49696

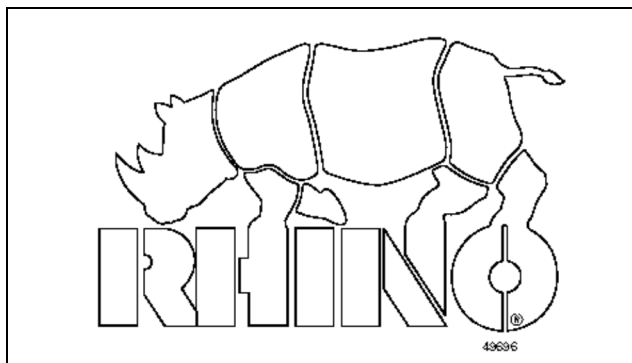

Rhino, Right

P/N 51448

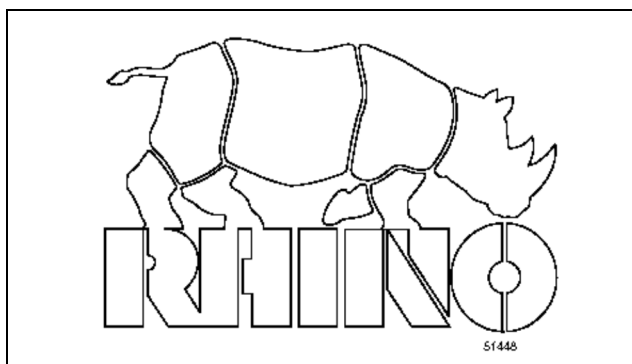

Slow Moving Vehicle Decal. Keep SMV reflector clean and visible. DO NOT transport or operate without the SMV.

P/N 03200347

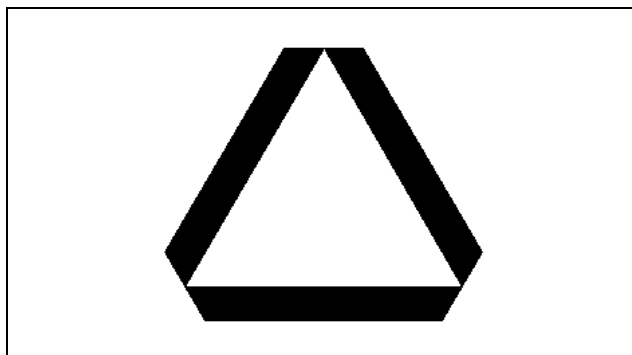

Read Operator's Manual! The operator's manual is located inside this canister. If the manual is missing order one from your dealer.

P/N 00776031

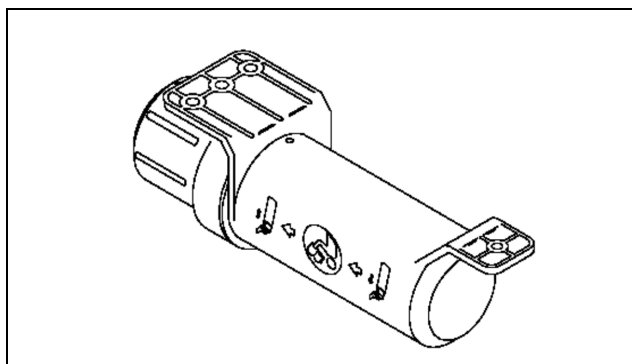

SAFETY

SAFETY

WARNING! - Crushing Hazard.

- To Avoid Serious Injury or Death
Make sure attachment is securely attached to the loader.
See Operator's Manual for instructions.
- Lock both levers down. Make sure pins are adequately extended through slots at the bottom of the attachment bracket and the tapered side of pin is firmly seated against attachment slots. Make sure the gap is not larger than 1/8".
- Tilt attachment down, lower to ground, apply down pressure, and drag backwards. Do not use attachment if it disengages.
- NEVER walk or work underneath raised loader or attachment

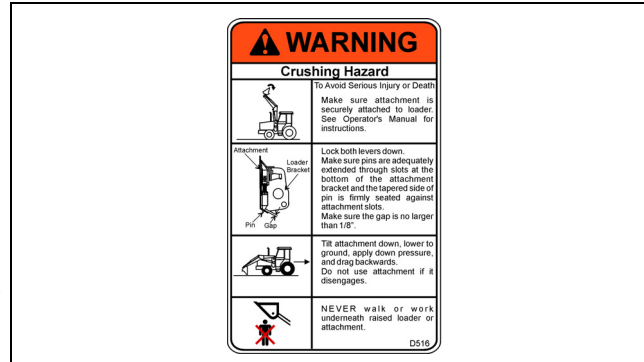

(Located on the Quick Attach Device Only)

P/N D516

SAFETY

SAFETY

Federal Laws and Regulations

This section is intended to explain in broad terms the concept and effect of federal laws and regulations concerning employer and employee equipment operators. This section is not intended as a legal interpretation of the law and should not be considered as such.

Employer-Employee Operator Regulations

U.S. Public Law 91-596 (The Williams-Steiger Occupational and Health Act of 1970) OSHA

This Act Seeks:

“...to assure so far as possible every working man and woman in the nation safe and healthful working conditions and to preserve our human resources...”

DUTIES

Sec. 5 (a) Each employer-

- (1) shall furnish to each of his employees employment and a place of employment which are free from recognized hazards that are causing or are likely to cause death or serious physical harm to his employees;
- (2) shall comply with occupational safety and health standards promulgated under this Act.
- (b) Each employee shall comply with occupational safety and health standards and all rules, regulations and orders issued pursuant to this Act which are applicable to his own actions and conduct.

OSHA Training Requirements

Title 29, Code of Federal Regulations Part 1928.57(a)(6). www.osha.gov

Operator instructions. At the time of initial assignment and at least annually thereafter, the employer shall instruct every employee who operates an agricultural tractor and implements in the safe operating practices and servicing of equipment with which they are or will be involved, and of any other practices dictated by the work environment.

Keep all guards in place when the machine is in operation;

Permit no riders on equipment

Stop engine, disconnect the power source, and wait for all machine movement to stop before servicing, adjusting, cleaning or unclogging the equipment, except where the machine must be running to be properly serviced or maintained, in which case the employer shall instruct employees as to all steps and procedures which are necessary to safely service or maintain the equipment.

Make sure everyone is clear of machinery before starting the engine, engaging power, or operating the machine.

Employer Responsibilities:

To ensure employee safety during Tractor and Implement operation, it is the employer's responsibility to:

1. Train the employee in the proper and safe operation of the Tractor and Implement.
2. Require that the employee read and fully understand the Tractor and Implement Operator's manual.
3. Permit only qualified and properly trained employees to operate the Tractor and Implement.
4. Maintain the Tractor and Implement in a safe operational condition and maintain all shields and guards on the equipment.
5. Ensure the Tractor is equipped with a functional ROPS and seat belt and require that the employee operator securely fasten the safety belt and operate with the ROPS in the raised position at all times.
6. Forbid the employee operator to carry additional riders on the Tractor or Implement.
7. Provide the required tools to maintain the Tractor and Implement in a good safe working condition and provide the necessary support devices to secure the equipment safely while performing repairs and service.
8. Require that the employee operator stop operation if bystanders or passersby come within 300 feet.

Child Labor Under 16 Years of Age

Some regulations specify that no one under the age of 16 may operate power machinery. It is your responsibility to know what these regulations are in your own area or situation. (Refer to U.S. Dept. of Labor, Employment Standard Administration, Wage & Home Division, Child Labor Bulletin #102.)

INTRODUCTION SECTION

INTRODUCTION

INTRODUCTION

The 1598 Loader is designed with care and built with quality materials by skilled workers. Proper assembly, maintenance, and operating practices, as described in this manual, will help the owner/operator get years of satisfactory service from the machine.

The purpose of this manual is to familiarize and instruct. The Assembly Section instructs the owner/operator in the correct assembly of the Front End Loader using standard and optional equipment. The Parts manual is designed to familiarize the owner/operator with replaceable parts on the Loader. This Part Manual provides exploded assembly drawings of each Loader component illustrating each piece and the corresponding part number.

Careful use and timely service saves extensive repairs and costly downtime losses. The Operation and Maintenance Sections of the manual train the owner/operator how to work the Front End Loader correctly and attend to appropriate maintenance. The Trouble Shooting Guide helps diagnose difficulties and offers solution to the problems.

Safety is of primary importance to the owner/operator and to the manufacturer. The first section of this manual includes a list of Safety Messages, that, if followed, will help protect the operator and bystanders from injury or death. Many of the Safety Messages will be repeated throughout the manual. The owner/operator/dealer should know these Safety Messages before assembly and be aware of the hazards of operating this Loader during assembly, use, and maintenance. The Safety Alert Symbol combined with a Signal Word, as seen below, is intended to warn the owner/operator of impending hazards and the degree of possible injury faced when operating this machine.



WARNING

It is recommended that tractor wheels be moved to the widest setting and rear ballast be applied to increase tractor stability.



DANGER

Never allow children to operate, ride on, or come close to the Tractor or Implement. Usually, 16-17 year-old children who are mature and responsible can operate the implement with adult supervision, if they have read and understand the Operator's Manuals, been trained in proper operation of the tractor and Implement, and are physically large enough to reach and operate the controls easily. (SG-11)



DANGER

Never allow children or other persons to ride on the Tractor or Implement. Falling off can result in serious injury or death. (SG-10)



DANGER

Never allow children to play on or around Tractor or Implement. Children can slip or fall off the Equipment and be injured or killed. Inadvertent contact with controls can cause the Implement to shift or fall crushing themselves or others. (SG-25)

INTRODUCTION

DANGER

DO NOT use drugs or alcohol immediately before or while operating the Tractor and Implement. Drugs and alcohol will affect an operator's alertness and coordination and therefore affect the operator's ability to operate the equipment safely. Before operating the Tractor or Implement, an operator on prescription or over-the-counter medication must consult a medical professional regarding any side effects of the medication that would hinder their ability to operate the Equipment safely. NEVER knowingly allow anyone to operate this equipment when their alertness or coordination is impaired. Serious injury or death to the operator or others could result if the operator is under the influence of drugs or alcohol. (SG-27)

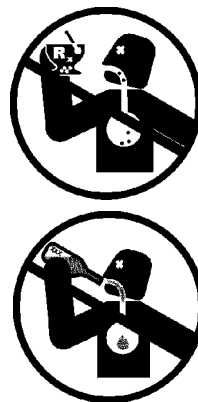

WARNING

Engine Exhaust, some of its constituents, and certain vehicle components contain or emit chemicals known to the state of California to cause cancer and birth defects or other reproductive harm. (SG-30)

DANGER

Never walk or work under any raised boom or bucket. The Boom could fall and cause serious bodily injury or death. Always lower the boom and bucket flat on the ground or support the Boom and bucket on safety stands. Unload all hydraulic actuators prior to performing any maintenance. To do this, set the bucket on the ground then kill the tractor engine. Push and pull the control levers in and out several times to remove pressure. Do not work under raised Boom or Bucket unless components are securely blocked up to prevent inadvertent dropping. (SBH-7)

WARNING

Operate this Equipment only with a Tractor equipped with an approved roll-over-protective system (ROPS). Always wear seat belts. Serious injury or even death could result from falling off the tractor--particularly during a turnover when the operator could be pinned under the ROPS. (SG-7)



INTRODUCTION

INTRODUCTION



The RHINO 1598 Loader is designed for four-wheel drive tractors. They are intended to lift only loose materials that will fit in the bucket. All cylinders are double-acting. Parking stands support loader so tractor can be “driven in” for quick attaching.

Front and rear, and left and right are determined by the normal direction of travel (the same as on your automobile).

INTRODUCTION

Attention Owner/Operator

BEFORE OPERATING THIS MACHINE:

1. Carefully read the Operator's Manual, completely understand the Safety Messages and instructions, and know how to operate correctly both the tractor and implement.
2. Fill out the Warranty Card in full. Be sure to answer all questions, including the Serial Number of the implement. Mail within 30 days of delivery date of this implement.
NOTE: *Warranties are honored only if completed "Owner Registration and Warranty" forms are received by Alamo Group within thirty days of delivery of the implement.*
3. Record the Loader Model and Serial Numbers on the Warranty page. Keep this as part of the permanent maintenance file for the implement

IMPORTANT

For your safety and to guarantee optimum product reliability, always use Genuine RHINO replacement parts. The use of inferior "will-fit" parts will void Warranty of your RHINO implement and may cause premature or catastrophic failure which can result in serious injury or death. If you have any questions concerning the repair parts you are using, contact Rhino, 1020 S. Sangamon Ave., Gibson City, Illinois 60936 A Member of Alamo Group



INTRODUCTION

ASSEMBLY SECTION

ASSEMBLY

General Information



To avoid injury during installation of the loader attachment, do not allow bystanders within 10 feet of loader or attachment.



Always wear safety glasses when removing or installing buckets.



Always use a drift and hammer made of non-sparking material (a shot-filled mallet is recommended) to install or remove pins. A steel hammer or drift could generate flying metal fragments and result in injury. Always wear safety glasses when using a hammer to remove or install pins.



Always have a heavy attachment, such as a bucket mounted on loader when it is removed from tractor.



It is important not to put excessive weight on parking stands with lift cylinder retraction. Damage may result.



Never allow anyone to get under the loader or attachment or to reach through the loader lift arms when raised. Serious injury could result from crushing or pinching by the loader or attachment. (SL-06)



Make sure the loader is properly attached to the tractor and the retaining pins securely lock the loader into position. Improper mounting of the loader onto the tractor can result in the loader falling causing serious injury. (SL-23)

ASSEMBLY

WARNING

Do not use an attachment that is not securely attached to the quick hitch. The attachment could fall resulting in severe crushing injuries or death to the operator or bystanders.

- Rotate both hitch pin levers down to the locked position. You should feel a firm resistance when locking the levers down. The pins must extend through the slots in the bottom of the attachment bracket.
- Examine the fit between the quick hitch and the bottom of the attachment bracket. The pins must extend through the slots in the bottom of the attachment bracket. The tapered side of each pin must be firmly wedged against the surface of the slot on the bottom of the attachment bracket. The attachment bucket should fit snugly against the bottom of the quick hitch bracket. If there is a gap of more than 1/8" or if the pins are not firmly seated do not use the attachment. Contact your dealer before using the attachment.
- On level ground, tilt the attachment down 90° degrees and lower it to the ground. Lower the loader further to slightly raise the front of the tractor off the ground. Drive the tractor in reverse while the attachment is on the ground for 20-30 feet to ensure the attachment does not disconnect. If the attachment disconnects during this process, discontinue the use of the attachment and contact your dealer.

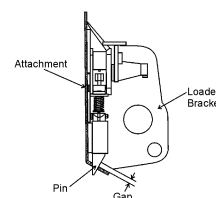
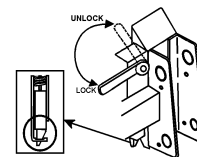

WARNING

NEVER walk or work under or allow any person to be underneath a raised loader or attachment. (SL-15)



WARNING

Only mount the loader on a tractor that is listed on the mounting instructions. Never mount on a tricycle steering front axle. Move the tractor front and rear wheels to the widest spacing and add the recommended rear tractor ballast to prevent tractor tip over. Keep the tractor tires properly inflated. Maintain at least 25% of the total Tractor and Loader weight including the maximum load in the bucket or attachment on the rear axle. Always wear your seatbelt and make sure the ROPS structure is fully deployed to prevent serious injury or death from the tractor tipping over. (SL-11)

CAUTION

Make sure all air is purged from the hydraulic system before using the loader. Air in the system can cause the loader to respond sluggishly or with unexpected movement. The air can be purged from the cylinder lines by fully cycling the cylinders several times from the fully closed to fully open position. Sudden or unexpected movement or dropping of the loader and attachment could result in serious injury. (SL-32)

ASSEMBLY

ASSEMBLY

Proper Ballasting and Wheel Spacing

Spread front wheels to maximum distance allowable without interfering with loader.

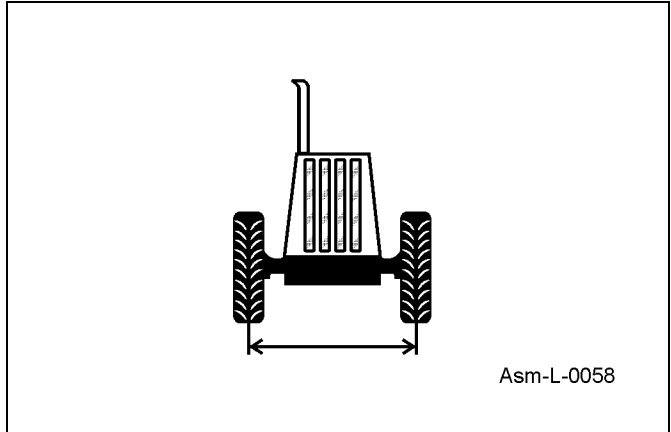

Spread rear wheels to maximum distance.

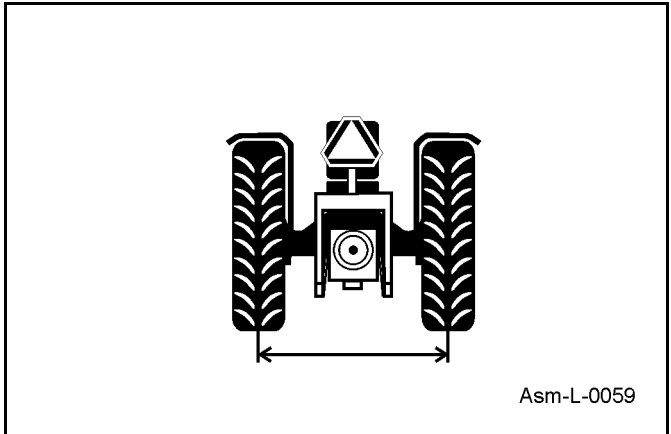

Add rear wheel weight, rear ballast box or implement. Make sure there is 25% of total weight on rear axle.

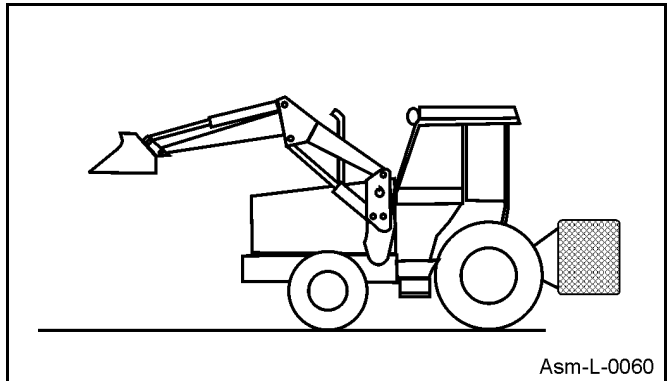

ASSEMBLY

Assembly Instructions



Never work under the Implement, the framework, or any lifted component unless the Implement is securely supported or blocked up to prevent sudden or inadvertent falling which could cause serious injury or even death. (SL-36)



Never allow anyone to get under the loader or attachment or to reach through the loader lift arms when raised. Serious injury could result from crushing or pinching by the loader or attachment. (SL-06)



Do not modify or alter this Implement. Do not permit anyone to modify or alter this Implement, any of its components or any Implement function. (SG-8)



Never interfere with factory-set hydraulic calibrations. Any change in calibration could cause a failure of the equipment and may result in injury. (SBH-13)

Mounting Kit can be installed using tools ordinarily available, including a hoist capable of lifting and supporting the loader for initial mounting, standard and metric wrenches, torque wrench, and hydraulic oil.

Tractor-supplied hydraulic power is required for loader mounting and operation.

The grille guard (4) may be installed with or without the loader. Refer to Instructions on **Page 3-8**.

Check tractor tire pressure. Refer to tractor operator's manual for recommended pressures. With tractor on a firm level surface, compare tractor rear axle height from left to right; measuring from axle center to ground. Adjust air pressure in rear tires until axle height measures same for both sides.

NOTE: *If rear axle on tractor is not level from side to side, cutting edge on loader bucket or similar loader-mounted attachments will not sit flat on ground.*

Tractor steering stops may have to be adjusted to provide clearance between front tire and loader on full left and right turn with front axle fully oscillated. Be sure lift cylinders are fully retracted when checking tire clearances. Refer to tractor operator's manual for steering stop adjustment.

NOTE: *Reference to left and right used in these instructions refer to position when seated in the operating position on tractor.*

ASSEMBLY

Preparing Tractor

Shut off engine, engage brakes and remove key during installation. If tractor is equipped with front weights, remove weights and weight bracket.

Remove plastic thread protectors from holes on left and right sides of tractor clutch housing and front axle.

Important

Clean threaded holes in tractor chassis thoroughly using a tap of proper size. Paint, rust or debris in the threads may not permit cap screws to be installed and tightened correctly.

Pallet Component Removal

The loader boom, bucket, left and right midmounts, hydraulic package, and grille guard come on one pallet. Remove plastic protective cover from pallet. Untie and remove grille guard from pallet. Support midmounting brackets and untie and remove from pallet. Remove hydraulic box of parts from pallet. Support bucket then remove hold downs and remove from pallet.

NOTE: Support midmounting brackets when removing from shipping materials.

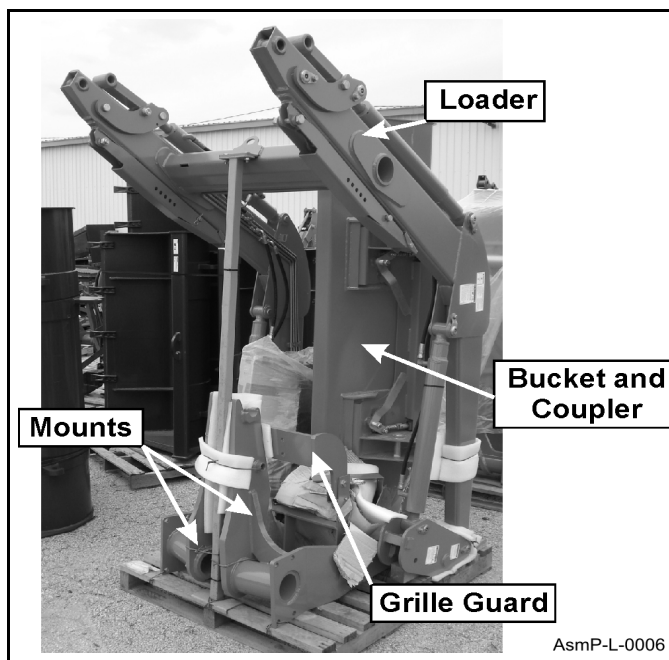

WARNING

Loader must be supported before removing hardware securing loader to shipping pallet or loader will tip over.

Support loader boom arms with lifting device and nylon straps. Lift loader slightly to remove load from support post and remove it.

Lower loader boom onto ground, positioning scraps of cardboard on floor under loader to prevent loader paint damage. Remove pallet.

NOTE: Do not tighten hardware to full torque until the mounting kit is completely assembled unless otherwise noted. This will allow proper assembly and alignment of parts as they are installed. Before finally tightening all mounting hardware, start the engine and apply downward pressure to the loader bucket, removing the load from the front tires (Do not lift tires off the ground!) Make sure the mounting pins can be rotated easily.

ASSEMBLY

Installing Left and Right Midmounting Brackets

1. Unfasten valve mount from right side of tractor frame and remove spacer.
2. Lift right and midmounting bracket (1) with overhead hoist. Fasten right midmounting bracket and valve mount (1) to tractor casting and front axle housing using HHCS M16 x 40MM (7) and M16 lockwashers (9).
3. Raise lift midmounting bracket (2) with overhead hoist. Fasten left midmounting bracket (2) to tractor casting and front axle housing using HHCS M16 x 40 (7) and M16 lockwashers (9).
4. Attach back axle bar (3) to bottom of the inside of the uprights and to the back axle of the tractor using the M16 x 50 bolt, M16 washer and M16 nuts. Repeat on the other side.

Installing Manual Canister to Boom Assembly

1. Use two 1/4"-20 bolts, 1/4" washer and 1/4"-20 nut to attach canister to bracket.
2. Remove bolts (26) and washers (28) from cover (10).
3. Using bolts that were just removed, attach bracket and cover to boom assembly.
4. Ensure manual is placed in the canister.

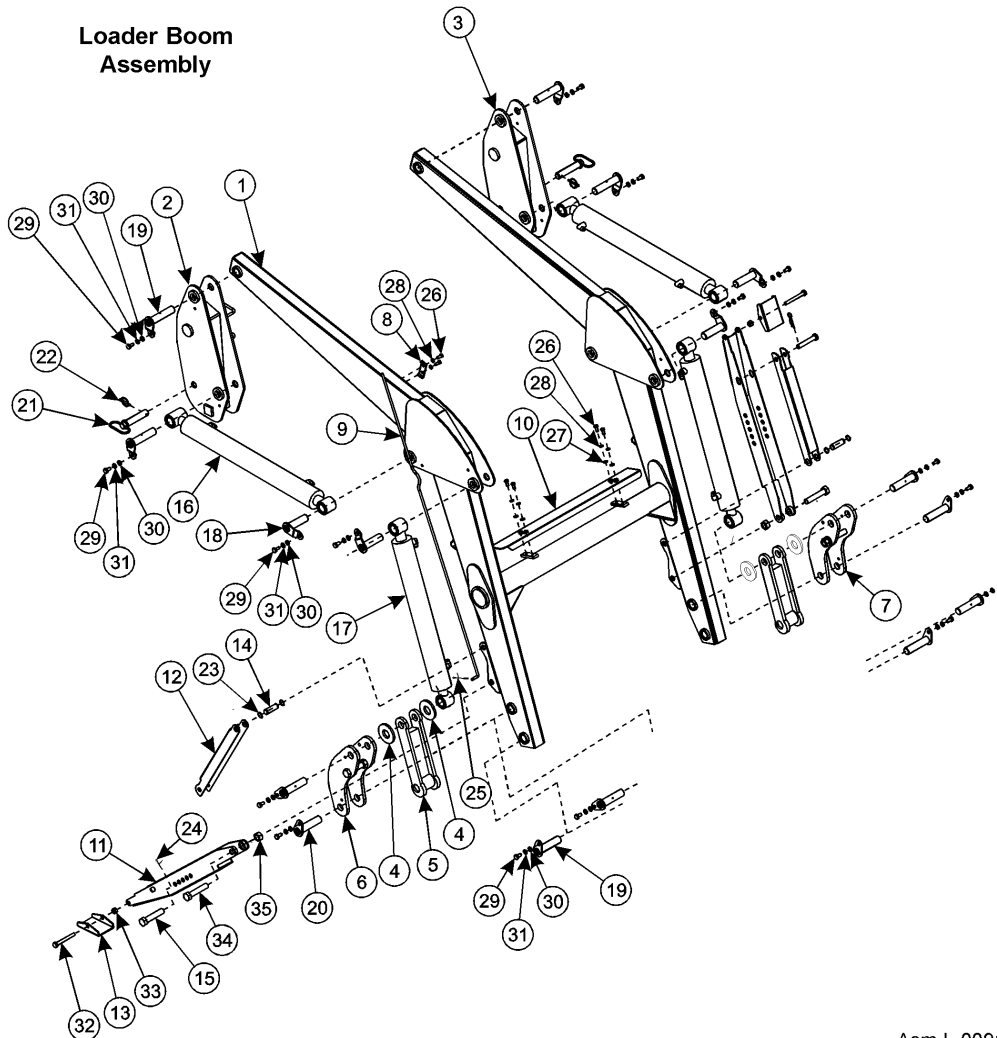

Asm-L-0091

ASSEMBLY

ASSEMBLY

Installing Grille Guard

1. Position grille guard on front of tractor.
2. Secure with HHCS M14 x 45MM (5) and M14 lockwashers (6).
3. Torque bolts after all have been installed using General Torque Specifications (See **Torque for Fasteners in Maintenance Section**).

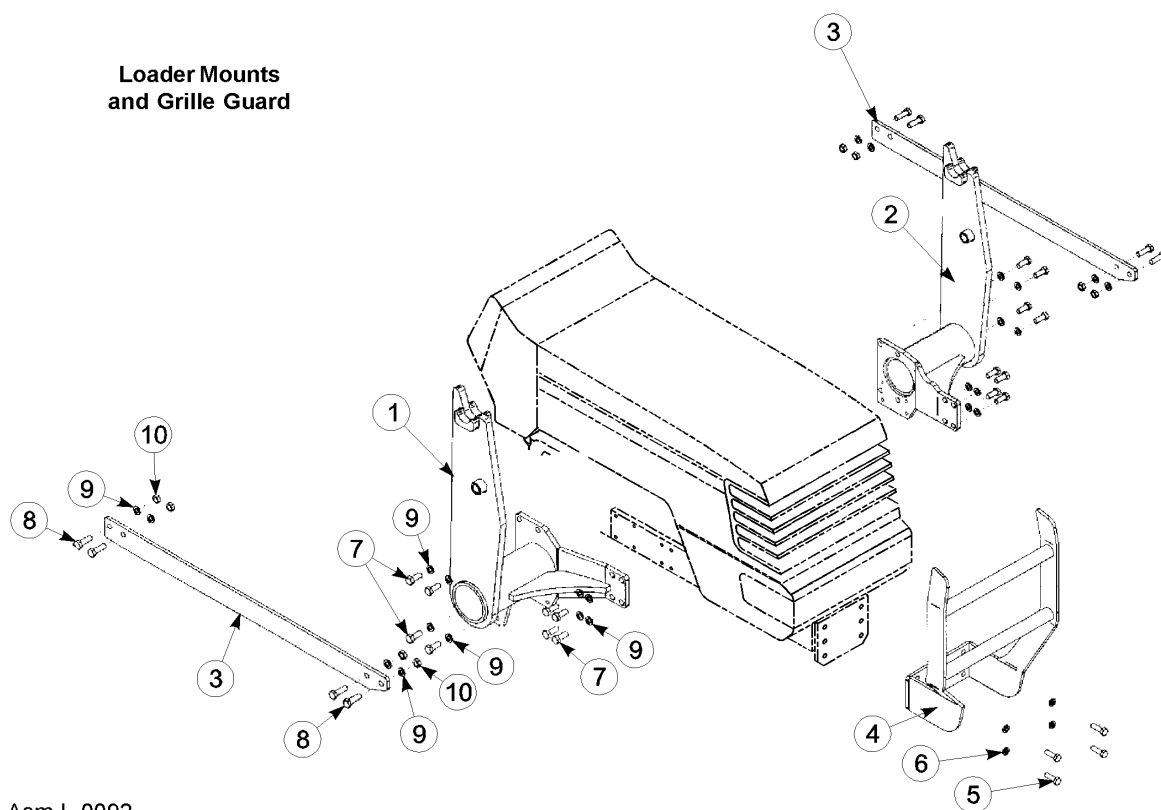

ASSEMBLY

Plumbing Loader

1. Replace male couplers supplied with the tractor to the new ones with the loader keeping the colors consistent.
2. Place sleeve over four hoses.
3. Connect hoses (4) to the adapter fittings, starting from the bottom tube (5).
4. Install dust caps onto the free end of the hoses, making sure that the color codes shown in **Chart 1** below.
5. Connect hoses to the valve, keeping the colors consistent.

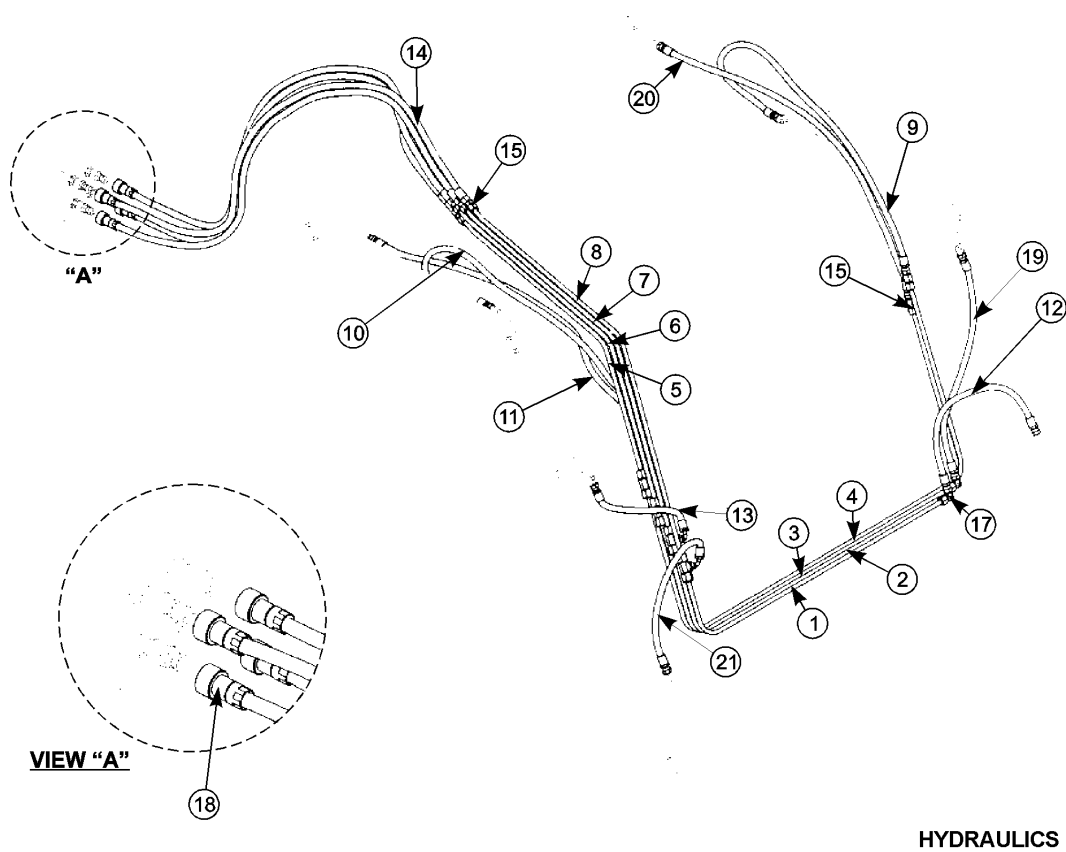

Chart 1

Port Identification

- Port #1 - Red, Tilt Cylinder Rod End
- Port #2 - Blue, Tilt Cylinder Base End
- Port #3 - Yellow, Lift Cylinder Base End
- Port #4 - Black, Lift Cylinder Rod End

ASSEMBLY

Mounting Loader to Tractor

WARNING

To avoid injury during installation of quick attach loader, an overhead hoist must be used for initial mounting, do not permit bystanders within ten feet of loader. Parking stands are not operational without bucket or heavy attachment mounted. Bale spear or pallet fork alone do not provide enough weight.

1. Secure a hoist strap around loader upper boom arms and slowly raise loader with overhead hoist until loader uprights are slightly higher than mounts on the tractor. Make sure loader is centered with the tractor.
2. Start tractor, release brakes, and drive tractor forward until mounts are touching. Engage brakes and shut off tractor.
3. With overhead hoist, lower loader until loader upright mounted are seated in saddle of tractor mounts. Connect hydraulic hoses to correct ports. See Chart below.
4. Start tractor and extend lift cylinders, rotating the loader upright until the lower connector pin holes line up with holes in tractor mount. Shut off tractor and engage brakes. Insert both lower connection pins and safety lynch pins.

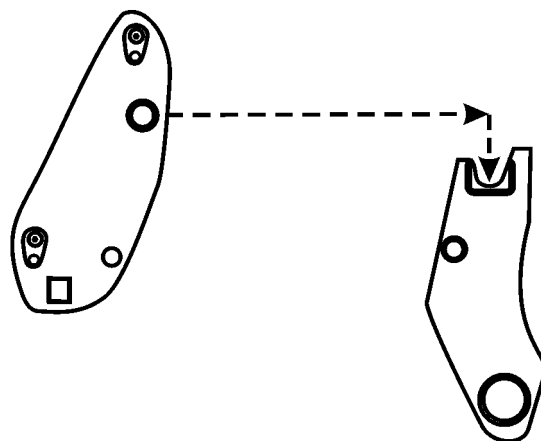

Asm-L-0073

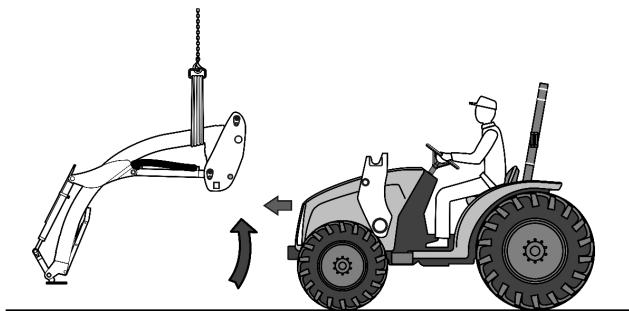

Asm-L-0074

ASSEMBLY

Attaching Bucket to Loader



To avoid injury during installation of bucket, do not allow bystanders within 10 feet of loader and bucket.

1. Locate tractor and bucket on level ground. Lower boom to the ground and extend the bucket cylinders slightly while raising the boom to provide 3" to 5" of ground clearance. Drive tractor forward to the bucket, aligning the loader's quick attach device with the pockets on the back of the bucket.
2. While driving forward slowly to maintain contact with the bucket, lift the bucket and tilt it back until the loader's quick attach device is seated in the bucket pockets.
3. Shut off tractor engine, set park brake. Move the bucket latching handles on the loader's quick attach device down to the LATCH position.
4. Start the tractor and activate lift cylinders to raise bucket one or two feet. Tilt the bucket downward so that the latching mechanism is visible and inspect to make sure the pins are engaged through the latch plate on the back of the bucket. Lower the bucket to the ground and back up slowly with slight downward pressure on the bucket to make sure it remains attached.
5. Before finally tightening all mounting hardware, retract the bucket so the bottom is level with the ground and lower the bucket to the ground to apply downward pressure until the load is taken off the tractor's front tires.

NOTE: Do not lift the tractor tires off the ground. While pressure is applied, make sure the loader mounting pins can be rotated easily.

6. Tighten all remaining hardware to the torque level shown in the General

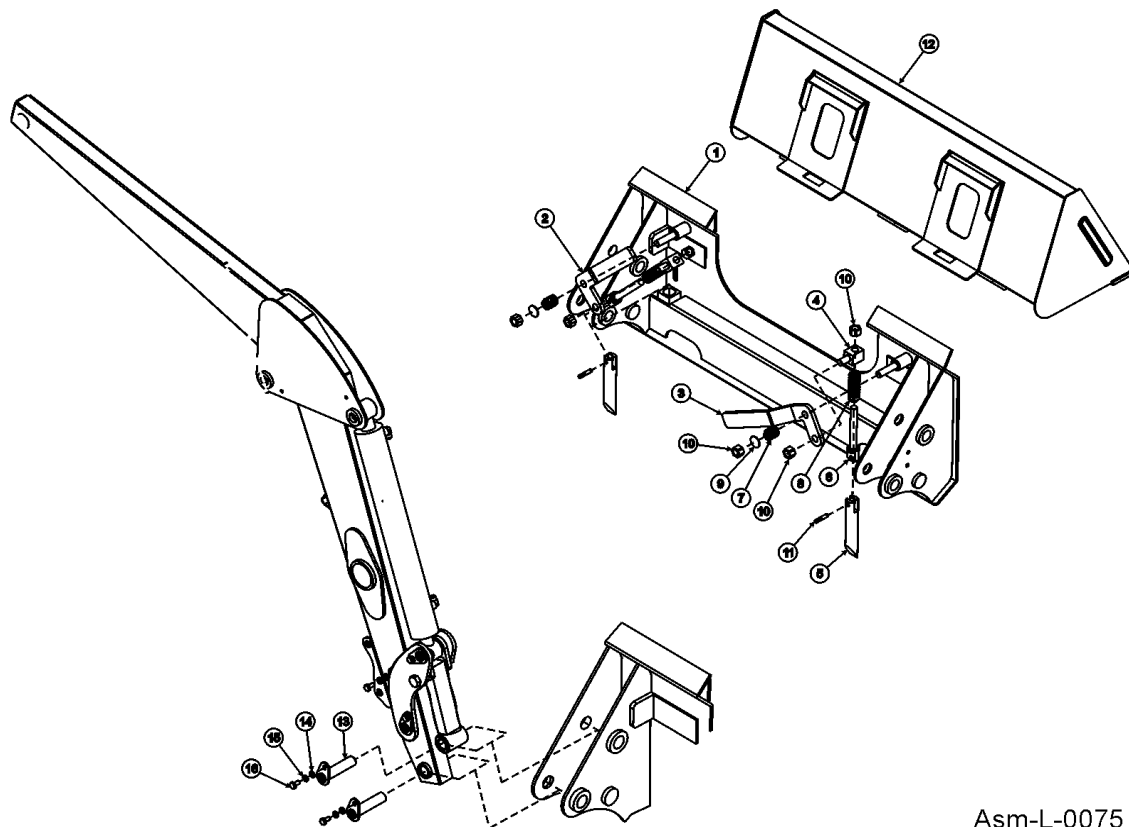

Asm-L-0075

ASSEMBLY

ASSEMBLY

Connecting Quick Attach Device (Optional)

When Connecting an Attachment to the Loader Quick Hitch

1. Be sure both quick hitch pin levers are in the unlocked position, with the levers pointing up. Tilt the loader quick hitch forward, drive the loader into the attachment bracket and engage top of the quick hitch into the top of the attachment bracket.
2. Raise the loader slightly and rotate the top of the quick hitch back toward the operator until the bottom of the attachment is seated firmly in the bottom of the quick hitch.
3. Rotate the quick hitch pin levers down 90 degrees to the locked position. You should feel a firm resistance when locking the levers down. The tapered pins must extend through the slots in the bottom of the attachment bracket. The tapered side of the pins must be firmly wedged against the surface of the slot at the bottom of the attachment bracket. If the pins are not wedged securely in place, the attachment may fall off resulting in possible severe crushing injury or death to the operator or bystander.
4. Raise the loader and attachment to shoulder height. By standing at the side of the loader, inspect the connection between the quick hitch and attachment.

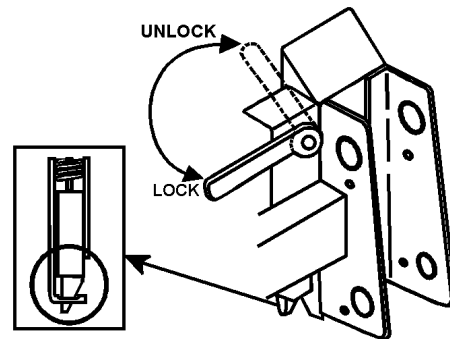

Asm-L-0102



Never walk or work under or allow any person to be underneath a raised loader or attachment.



- Examine the fit between the quick hitch and the bottom of the attachment bracket. The pins must extend through the slots in the bottom of the attachment bracket. The tapered side of each pin must be firmly wedged against the surface of the slot on the bottom of the attachment bracket. The attachment bracket should fit snugly against the bottom of the loader bracket. If there is a gap of more than 1/8" or if the pins are not firmly seated do not use the attachment. Contact your dealer before using the attachment.

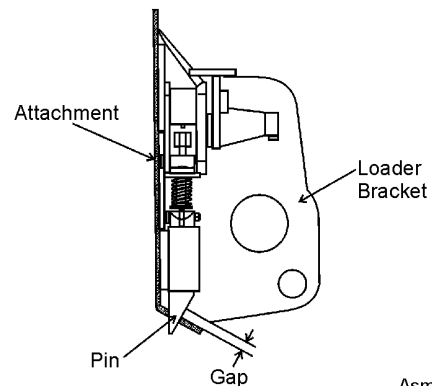

Asm-L-0103

ASSEMBLY

5. On level ground, tilt the attachment down 90 degrees and lower it to the ground. Lower the loader further to slightly raise the front of the tractor off the ground. Drive the tractor in reverse while the attachment is on the ground for 20-30 feet to insure the attachment does not disconnect. If the attachment disconnects during this process, discontinue the use of attachment and contact your dealer.

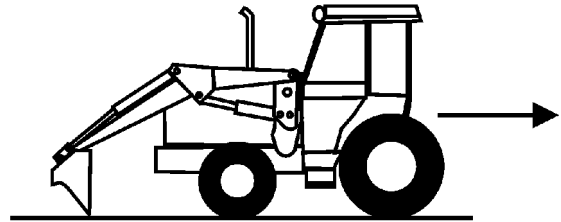

Asm-L-0104

Pre-Operation Check

1. Adjust front wheel tread setting stops, if necessary, to provide a minimum 3/4" clearance between front tires and any part of loader with lift cylinders fully oscillated. Be sure lift cylinders are fully retracted. Refer to **page 3-5**, under **Preparing the Tractor**. Refer to Tractor Operator's Manual for tread setting and steering stop adjustment procedures.
2. Lubricate all grease fittings with SAE multi-purpose grease.
3. Check hydraulic fluid level in tractor. Fill to recommend level, using oil specified in the Proper Torque for Fasteners Chart in the **Maintenance Section**.

ASSEMBLY

ASSEMBLY

Dismounting the Loader

1. Locate tractor and loader on firm level ground.
2. With bucket raised above ground, tilt bucket down approximately 30 degrees from level.
3. Lower boom by retracting lift cylinders to lift tractor front end (tires can be off ground).
4. Stop Engine. Allow tractor front end to lower by relaxing ONLY lift cylinders with control lever. This will remove pressure on hitch pins (See Figure Asm-L-0002).

Asm-L-0002

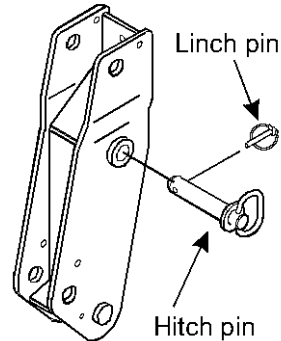

NOTE: Do not relax bucket Cylinders.

5. Set parking brake. Rotate parking stands from storage position by removing lynch pins and clevis pins. Reinstall clevis pins and lynch pins when parking stands are in operation position (See Figure Asm-L-0001).
6. Remove lynch pins and 1" hitch pins from loader upright.
7. Start tractor engine and release brakes. Retract bucket cylinders to allow parking stands to contact ground.

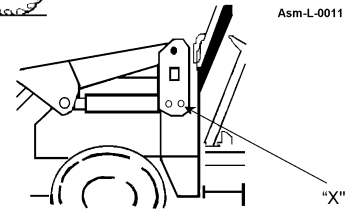
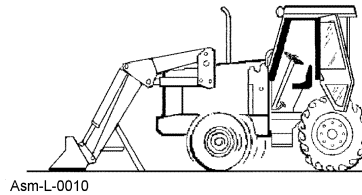

WARNING

It is important not to put excessive weight on parking stands with lift cylinder retraction. Damage may result.

8. Extend lift cylinders 6" to 8" to rotate top of loader uprights forward out of the mount, allowing tractor to be pushed rearward. Retract bucket cylinders until lower loader upright pins clear mount pin saddles and front tires (See Figure Asm-L-0003).
9. Move tractor rearward approximately 6", being certain not to stretch hydraulic hoses.
10. Stop tractor engine and set parking brake. Relax lift cylinders and bucket cylinders by moving each control lever in both directions. Disconnect hydraulic hoses from tractor.
11. Start tractor engine and release brakes. Slowly back tractor out of loader.

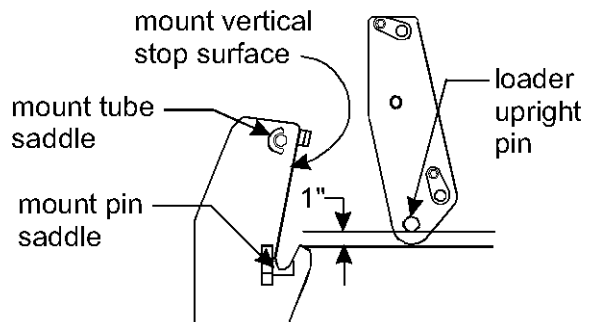

Asm-L-0003

ASSEMBLY

Mounting Loader

Mounting is basically reverse of dismounting.



WARNING To avoid injury during installation of the loader attachment, do not allow bystanders within 10 feet of loader or attachment.

1. Slowly drive tractor into loader approximately 6" from loader mounts. Shut off tractor engine and set parking brake.
2. Connect hydraulic hoses. Make sure couplers are clean before connecting together.
3. Start engine and release parking brake. Make sure lift cylinders are extended 6" to 8". Stroke bucket cylinders to raise or lower upright pin to clear each front mount pin saddle by approximately 1" (See Figure Asm-L-0003).
4. Drive tractor forward until loader upright pins contact mount vertical stop surfaces just above the mount pin saddles (See Figure Asm-L-0003). Extend bucket cylinders to FULLY seat both loader upright pins into mount pin saddles and raise parking stands off ground. Retract lift cylinders, allowing tractor to move forward. Continue until loader uprights have fully seated into back of mount tube saddles by retracting lift cylinders to raise tractor front end (tires can be off ground).
5. Stop engine. Allow tractor front end to lower by relaxing ONLY lift cylinders with control lever.
6. Set parking brake. Insert two 1" hitch pins and lynch pins.
7. Remove lynch pins and clevis pins from parking stands, rotate stands into storage position and secure with clevis pins and lynch pins (See Figure Asm-L-0001).

NOTE: If front wheel spacings were changed while loader was off tractor, tire clearances must be checked and possibly adjusted to insure proper clearances.



WARNING Always use a drift and hammer made of non-sparking material (a shot-filled mallet is recommended) to install or remove pins. A steel hammer or drift could generate flying metal fragments and result in injury. Always wear safety glasses when using a hammer to remove or install pins.

OPERATION SECTION

OPERATION

RHINO 1598 LOADER OPERATION INSTRUCTIONS

READ, UNDERSTAND, and FOLLOW the following Safety Messages. Serious injury or death may occur unless care is taken to follow the warnings and instructions stated in the Safety Messages. Always use good common sense to avoid hazards. (SG-2)



Si no lee ingles, pida ayuda a alguien que si lo lea para que le traduzca las medidas de seguridad. (SG-3)



Your 1598 Loader should now be assembled and inspected for any evidence of defective or damaged parts before use. Any evidence of damage should be reported to your dealer immediately.

This section of the Operator's Manual is designed to familiarize, instruct, and educate safe and proper loader use to the operator. Pictures contained in this section are intended to be used as a visual aid to assist in explaining the operation of 1598 loader and are not necessarily of 1598 loader or exact tractor. Some pictures may show shields removed for purposes of clarity. NEVER OPERATE this implement without all shields in place and in good operational condition. The operator must be familiar with the loader and tractor operation and all associated safety practices before operating the loader and tractor. Proper operation of the loader, as detailed in this manual, will help ensure years of safe and satisfactory use of the loader.

READ AND UNDERSTAND THE ENTIRE OPERATING INSTRUCTIONS AND SAFETY SECTION OF THIS MANUAL AND THE TRACTOR MANUAL BEFORE ATTEMPTING TO USE THE TRACTOR AND IMPLEMENT. If you do not understand any of the instructions, contact your nearest authorized dealer for a full explanation. Pay close attention to all safety signs and safety messages contained in this manual and those affixed to the implement and tractor. *OPS-U- 0001*

OPERATION

1. Standard Equipment and Specifications

- Model 1598 Loaders are compatible with Kubota L3540 and L3240 Tractors.
- Each loader package includes the basic loader, mounting brackets, hydraulic plumbing, grill guard, quick attach device and bucket.

	1598
Tractor	L4240, L4740, L5040, L5740
(A) * Maximum Lift Height at Pivot Pin	110.5"
(B) * Maximum Lift Height under Level Bucket	102"
(C) * Clearance with Bucket Dumped	79.5"
(D) Reach at Maximum Height	17"
(E) Maximum Dump Angle	55°
(F) Reach with Attachment on Ground	80"
(H) * Digging Depth	10"
(U) Lift Capacity to Max Height at Pivot Pin	2700 lbs
(V) Lift Capacity 500mm Forward of Pivot Pin at Full Height	2030 lbs
(W) Lift Capacity 500mm Forward of Pivot Pin at 59°	2290 lbs
(Y) Breakout Force at Pivot Pin	3510 lbs
Bucket Size and Type	73" Quick Attach

Ops-884_A

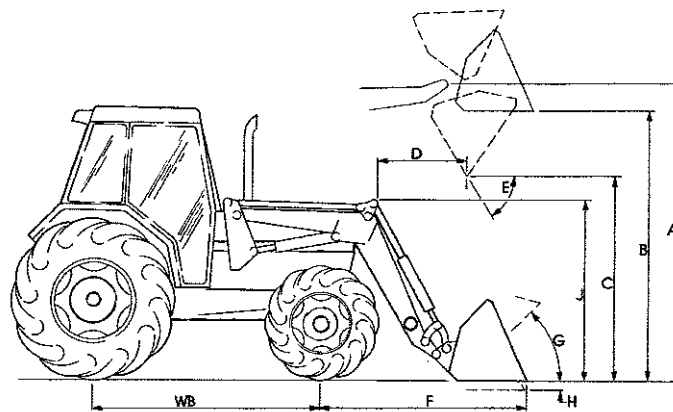

(*These Heights Are Subject to Tire Size Modifications)

OPERATION

2. Operator Requirements



DO NOT use drugs or alcohol immediately before or while operating the Tractor and Implement. Drugs and alcohol will affect an operator's alertness and coordination and therefore affect the operator's ability to operate the equipment safely. Before operating the Tractor or Implement, an operator on prescription or over-the-counter medication must consult a medical professional regarding any side effects of the medication that would hinder their ability to operate the Equipment safely. NEVER knowingly allow anyone to operate this equipment when their alertness or coordination is impaired. Serious injury or death to the operator or others could result if the operator is under the influence of drugs or alcohol. (SG-27)



Never operate the Tractor or Implement until you have read and completely understand this Manual, the Tractor Operator's Manual, and each of the Safety Messages found in the Manual or on the Tractor and Implement. Learn how to stop the tractor engine suddenly in an emergency. Never allow inexperienced or untrained personnel to operate the Tractor or Implement without supervision. Make sure the operator has fully read and understood the manuals prior to operation. (SG-4)

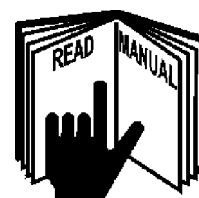

The operator and all support personnel should wear hard hats, safety shoes, safety glasses, and proper hearing protection at all times for protection from injury including injury from items that may be thrown by the equipment. (SG-16)

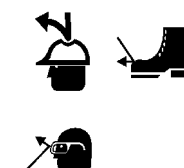

PROLONGED EXPOSURE TO LOUD NOISE MAY CAUSE PERMANENT HEARING LOSS! Tractors with or without an Implement attached can often be noisy enough to cause permanent hearing loss. We recommend that you always wear hearing protection if the noise in the Operator's position exceeds 80db. Noise over 85db over an extended period of time will cause severe hearing loss. Noise over 90db adjacent to the Operator over an extended period of time will cause permanent or total hearing loss. **NOTE:** *Hearing loss from loud noise [from tractors, chain saws, radios, and other such sources close to the ear] is cumulative over a lifetime without hope of natural recovery.* (SG-17)



OPERATION



Always read carefully and comply fully with the manufacturer's instructions when handling oil, solvents, cleansers, and any other chemical agent. (SG-22)



Never run the Tractor engine in a closed building or without adequate ventilation. The exhaust fumes can be hazardous to your health. (SG-23)



Battery posts, terminals and related accessories contain lead and lead compounds, chemicals known to the state of California to cause cancer, birth defects or other reproductive harm. (SG-31)



Prolonged operation may cause operator boredom and fatigue affecting safe operation. Take scheduled work breaks to help prevent these potentially impaired operating conditions. Never operate the Implement and Tractor in a fatigued or bored mental state which impairs proper and safe operation. (SG-32)



Use extreme caution when getting onto the Implement to perform repairs, maintenance and when removing accumulated material. Only stand on solid flat surfaces to ensure good footing. Use a ladder or raised stand to access high spots which cannot be reached from ground level. Slipping and falling can cause serious injury or death. (SG-33)



Use extreme care when loading, carrying or handling any agricultural fertilizers, chemicals or biological residue. Follow the manufacturer's handling instructions and wear appropriate Personal Protective Equipment including gloves, safety glasses and respirator when required. If you are using a tractor equipped with a cab, make sure the cab is rated for appropriate environmental exposure. Be safe and always wear proper protection. Short or long term exposure to certain chemicals and materials can result in serious injury or death. (SL-19)



OPERATION

WARNING

Repeated or substantial breathing of hazardous dusts, including crystalline silica, could cause fatal or serious respiratory disease including silicosis. Concrete, masonry, many types of rock, and various other materials contain silica sand. California lists respirable crystalline silica as a substance known to cause cancer. Operation of this equipment under certain conditions may generate airborne dust particles that could contain crystalline silica. In those conditions, personal protective equipment including an appropriate respirator must be used. If excessive dust is generated, a dust collection or suppression system should also be used during operation. (SG-41)

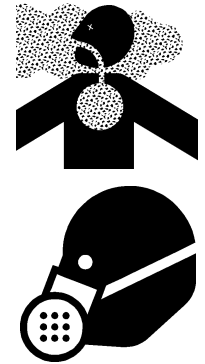

Safe operation of the unit is the responsibility of a qualified operator. A qualified operator has read and understands the implement and tractor Operator's Manuals and is experienced in implement and tractor operation and all associated safety practices. In addition to the safety messages contained in this manual, safety signs are affixed to the implement and tractor. If any part of the operation and safe use of this equipment is not completely understood, consult an authorized dealer for a complete explanation.

If the operator cannot read the manuals for themselves or does not completely understand the operation of the equipment, it is the responsibility of the supervisor to read and explain the manuals, safety practices, and operating instructions to the operator.

Safe operation of equipment requires that the operator wear approved Personal Protective Equipment (PPE) for the job conditions when attaching, operating, servicing, and repairing the equipment. PPE is designed to provide operator protection and includes the following safety wear:

PERSONAL PROTECTIVE EQUIPMENT (PPE)

- Protective Eye Glasses, Goggles, or Face Shield
- Hard Hat
- Steel Toe Safety Footwear
- Gloves
- Hearing Protection
- Close Fitting Clothing
- Respirator or Filter Mask (depends on operating conditions) OPS-L- 0021

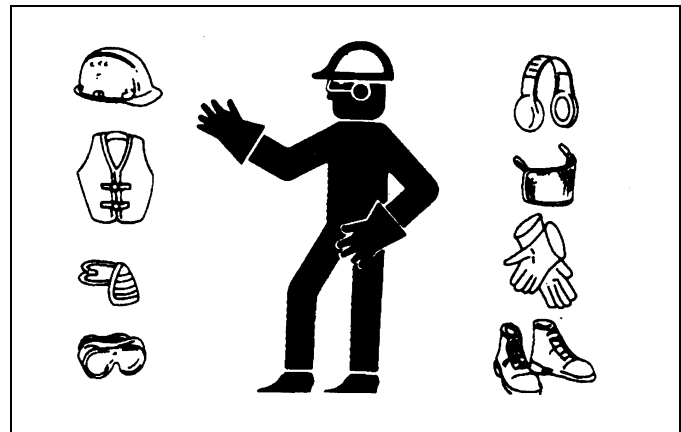

OPERATION

3. Tractor Requirements



Operate this Equipment only with a Tractor equipped with an approved roll-over-protective system (ROPS). Always wear seat belts. Serious injury or even death could result from falling off the tractor--particularly during a turnover when the operator could be pinned under the ROPS. (SG-7)



For added safety when lifting loads above the height of the operator, install a certified Falling Object Protective Structure. Shiftable loads, round bales, large loose items, and loader attachments can fall toward the operator resulting in serious injury or death. Falling Object Protective Structure (FOPS) rated Cab may be obtained from the tractor dealer or other sources. (SL-02)



Tractor Requirements and Capabilities

- ASABE approved Roll-Over Protective Structure (ROPS) or ROPS cab and seat belt
- Tractor Safety DevicesSlow Moving Vehicle (SMV) emblem, lighting
- Tractor BallastAs required to maintain 25% of gross weight of tractor, loader and bucket load on rear tires

3.1 ROPS and Seat Belt

The tractor must be equipped with a Roll-Over-Protective-Structure (ROPS) (tractor cab or roll-bar) and seat belt to protect the operator from falling off the tractor, especially during a roll over where the driver could be crushed and killed. Only operate the tractor with the ROPS in the raised position and seat belt fastened. Tractor models not equipped with a ROPS and seat belt should have these life saving features installed by an authorized dealer. OPS-U- 0003

3.2 Tractor Lighting and SMV Emblem

If the tractor will be operated near or traveled on a public roadway it must be equipped with proper warning lighting and a Slow Moving Vehicle (SMV) emblem which are clearly visible from the rear of the unit. Most tractor's have different settings for operating and transporting lighting. Refer to the tractor operator's manual for using the tractor's light switch and operating the turn signals.

OPS-B- 0017



OPERATION

3.3 Tractor Ballast



Before operating tractor and loader, add sufficient counterweight so a minimum of 25% of the total weight is on the rear axle. Total weight includes weight of: tractor, loader, rated load in bucket, and counterweight. Rated load is lift capacity at full height at 500mm forward of bucket pivot point. (See Standard Equipment and Specifications). When determining required counterweight bucket should be at maximum forward position (bucket pivot point at the same height as boom pivot point on mast).

3.4 Tractor Ballast

To ensure tractor stability when operating add wheel ballast or rear weights to rear tractor tires. For better stability, use tractor with wide front axle rather than tricycle front wheels. Move wheels to the tractor manufacturer's widest recommended settings to increase stability. If 3-Point hitch counterweights are used, they should be carried as low as possible at all times to maximize stability. Effective counterbalance weight at rear axle of mounted rear equipment is determined by multiplying actual weight of equipment by 1.50.

EXAMPLE: Equipment weighing 800 pounds, attached to tractor, multiplied by 1.50, equals 1200 pounds of effective counterbalance weight at rear axle.

A tractor that does not meet this criteria is DANGEROUS and should not be operated as upset of the unit can occur resulting in possible serious injury and property damage. **NOTE:** All factory mounted units are tested and meet the ballast requirement before shipment; further testing is not required unless the unit is operated in a manner other than what is considered standard operating conditions.

OPS-L- 0001

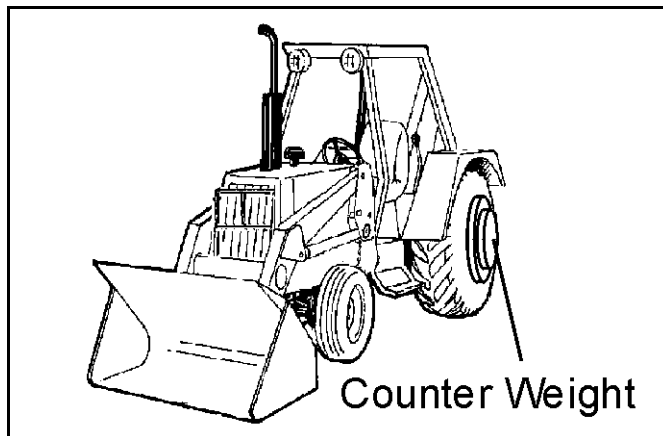

OPERATION

4. Getting On and Off the Tractor



Do not mount or dismount the Tractor while the tractor is moving. Mount the Tractor only when the Tractor and all moving parts are completely stopped. (SG-12)



Before getting onto the tractor, the operator must read and completely understand the implement and tractor operator manuals. If any part of either manual is not completely understood, consult an authorized dealer for a complete explanation. OPS-L- 0022

4.1 Boarding the Tractor



Never allow children or other persons to ride on the Tractor or Implement. Falling off can result in serious injury or death. (SG-10)



Never grasp control levers when mounting the machine. (SBH-4)

Use both hands and equipped handrails and steps for support when boarding the tractor. Never use control levers for support when mounting the tractor. Seat yourself in the operator's seat and secure the seat belt around you.

Never allow passengers to ride on the tractor or attached equipment. Riders can easily fall off and be seriously injured or killed from falling off and being ran over. It is the operator's responsibility to forbid all extra riders at all times. OPS-L- 0023

4.2 Dismounting the Tractor



BEFORE leaving the tractor seat lower the implement, set the parking brake and/or set the tractor transmission in parking gear, disengage the PTO, stop the engine, remove the key, and wait for all moving parts to stop. Place the tractor shift lever into a low range or parking gear to prevent the tractor from rolling. Never dismount a Tractor that is moving or while the engine is running. Operate the Tractor controls from the tractor seat only. (SG-9)

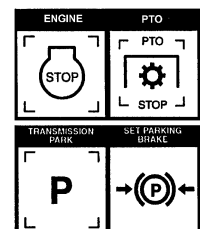

OPERATION



Before dismounting the tractor and loader lower the loader to the ground or onto solid support blocks. Engage the loader valve travel lock to prevent inadvertent movement of the valve controls causing the loader to suddenly move and drop. Sudden dropping of the loader and attachment could result in serious injury. (SL-05)

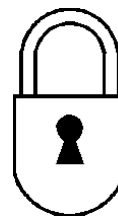

Before dismounting, park the tractor and implement on a reasonably level surface, apply the parking brake, idle the engine down, disengage the PTO, and lower the implement to the ground. Shut down the tractor engine according to the operator's manual, remove the key, and wait for all motion to completely stop. Never leave the seat until the tractor, its engine and all moving parts have come to a complete stop.

Use hand rails and steps when exiting the tractor. Be careful of your step and use extra caution when mud, ice, snow or other matter has accumulated on the steps or hand rails. Use all handrails and steps for support and never rush or jump off the tractor. OPS-L- 0024

5. Starting the Tractor



Never run the Tractor engine in a closed building or without adequate ventilation. The exhaust fumes can be hazardous to your health. (SG-23)



Start tractor only when properly seated in the Tractor seat. Starting a tractor in gear can result in injury or death. Read the Tractor operators manual for proper starting instructions. (SG-13)



OPERATION

The operator must have a complete understanding of the placement, function, and operational use of all tractor controls before starting the tractor. Review the tractor operator's manual and consult an authorized dealer for tractor operation instructions if needed.

Essential Tractor Controls:

- Locate the ignition switch
- Locate the light control lever
- Locate the engine shut off control
- Locate the engine throttle control
- Locate the brake pedals and the clutch
- Locate the parking brake
- Locate the PTO control
- Locate the 3-point hitch control lever
- Locate the hydraulic remote control levers

Before starting the tractor ensure the following:

- Conduct all pre-start operation inspection and service according to the tractor operator's manual.
- Make sure all guards, shields, and other safety devices are securely in place.
- The parking brake is on.
- The 3-point hitch control lever is in the lowered position.
- The hydraulic remote control levers are in the neutral position.
- The tractor transmission levers are in park or neutral.

Refer to the tractor owner's manual for tractor starting procedures. Only start the tractor while seated and belted in the tractor operator's seat. Never bypass the ignition switch by short circuiting the starter solenoid.

After the tractor engine is running, avoid accidental contact with the tractor transmission to prevent sudden and unexpected tractor movement. *OPS-L-0025*

OPERATION

6. Pre-Operation Inspection and Service



Periodically inspect all moving parts for wear and replace when necessary with authorized service parts. Look for loose fasteners, worn or broken parts, and leaky or loose fittings. Make sure all pins have cotter pins and washers. Serious injury may occur from not maintaining this machine in good working order. (SG-21)

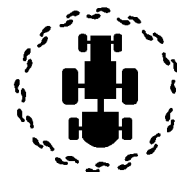

Never work under the Implement, the framework, or any lifted component unless the Implement is securely supported or blocked up to prevent sudden or inadvertent falling which could cause serious injury or even death. (SL-36)



Before each use, a pre-operation inspection and service of the implement and tractor must be performed. This includes routine maintenance and scheduled lubrication, inspecting that all safety devices are equipped and functional, and performing needed repairs. DO NOT operate the unit if the pre-operation inspection reveals any condition affecting safe operation. Perform repairs and replacement of damaged and missing parts as soon as noticed. By performing a thorough pre-operation inspection and service, valuable down time and repair cost can be avoided. OPS-L-0026

OPERATION

6.1 Tractor Pre-Operation Inspection/Service

Refer to the tractor operator's manual to ensure a complete pre-operation inspection and scheduled service is performed according to the manufacturers recommendations. The following are some of the items that require daily service and inspection:

- Tire condition/air pressure
- Wheel lug bolts
- Steering linkage
- PTO shield
- SMV sign is clean and visible
- Tractor's lights are clean and functional
- Tractor Seat belt is in good condition
- Tractor ROPS is in good condition
- ROPS is in the raised position
- No tractor oil leaks
- Radiator free of debris
- Engine oil level and condition
- Engine coolant level and condition
- Power brake fluid level
- Power steering fluid level
- Fuel condition and level
- Sufficient lubrication at all lube points
- Air filter condition *OPS-U-0030*



6.2 Loader Pre-Operation Inspection and Service



Periodically inspect all moving parts for wear and replace when necessary with authorized service parts. Look for loose fasteners, worn or broken parts, and leaky or loose fittings. Make sure all pins have cotter pins and washers. Serious injury may occur from not maintaining this machine in good working order. (SG-21)

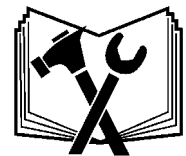

Avoid contact with hot surfaces including hydraulic oil tanks, pumps, motors, valves and hose connections. Relieve hydraulic pressure before performing maintenance or repairs. Use gloves and eye protection when servicing hot components. Contact with a hot surface or fluid can cause serious injury from burns or scalding. (SG-34)

OPERATION

WARNING

Do not operate this Equipment with hydraulic oil or fuel leaking. Oil and fuel are explosive and their presence could present a hazard. Do not check for leaks with your hand! High-pressure oil streams from breaks in the line could penetrate the skin and cause tissue damage including gangrene. To check for a hose leak, SHUT the unit ENGINE OFF and remove all hydraulic pressure. Wear oil impenetrable gloves, safety glasses and use Cardboard to check for evidence of oil leaks. If you suspect a leak, REMOVE the HOSE and have it tested at a Dealer. If oil does penetrate the skin, have the injury treated immediately by a physician knowledgeable and skilled in this procedure. (SG-15)



OPERATION

Before operation, a complete inspection and service is required to ensure the loader is in a good and safe working condition. Damaged and/or broken parts should be repaired and/or replaced immediately. To ensure the loader is ready for operation, conduct the following. OPS-L-0027

The operator's manual and safety signs affixed on the unit contain important instructions on the safe and proper use of the equipment. Maintain these important safety features on the implement in good condition to ensure the information is available to the operator at all times.

- Ensure the manual canister is secured to the equipment with the operator's manual inside.
- Ensure all safety signs are in place and legible. Replace missing, damaged, and illegible decals. OPS-U-0011

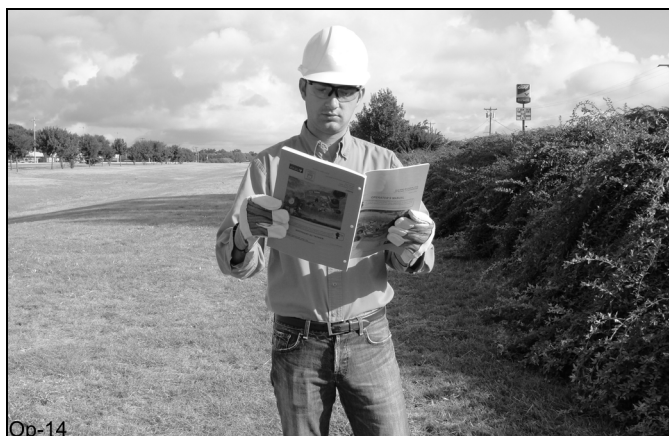

Op-14

MOUNT ASSEMBLY

- Inspect condition of mounting frame weldment.
- Ensure all bolts and screws are in position and are properly torqued.
- Ensure all pins are in place and fastened with screws.
- Ensure frame is properly mounted to tractor and hardware is properly installed and tightened. OPS-L-0004

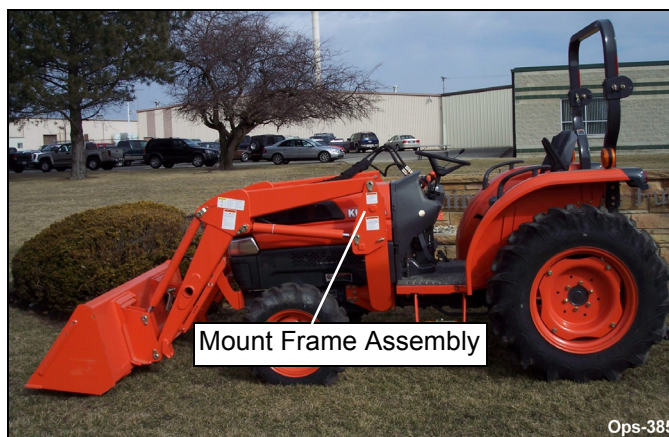

Mount Frame Assembly

Ops-385

OPERATION

LOADER BOOM ASSEMBLY

- Inspect condition of each arm section weldment
- Ensure all pins are in place.
- Ensure all bolts and screws are properly installed.
- Check condition of bushings at boom pivot points.
- Ensure each hydraulic cylinder is installed and retained correctly. Ensure the proper size pins are used to retain the cylinders in place and are secured properly. OPS-L-0005



HYDRAULIC LINE INSPECTION

- Check for hydraulic leaks along hoses, cylinders and fittings. **IMPORTANT: DO NOT use your hands to check for oil leaks. Use a piece of heavy paper or cardboard to check for hydraulic oil leaks.**
- Inspect the condition of the valve weldment.
- Ensure fitting is properly connected
- Inspect condition of bushings. OPS-L-0018



BUCKET INSPECTION

- Ensure all pins are in place.
- Ensure each hydraulic cylinder is installed and retained correctly. Ensure the proper size pins are used to retain the cylinders in place and are secured properly.
- Inspect the condition of the bucket lug weldments.
- Inspect condition of bushings. OPS-L-0007

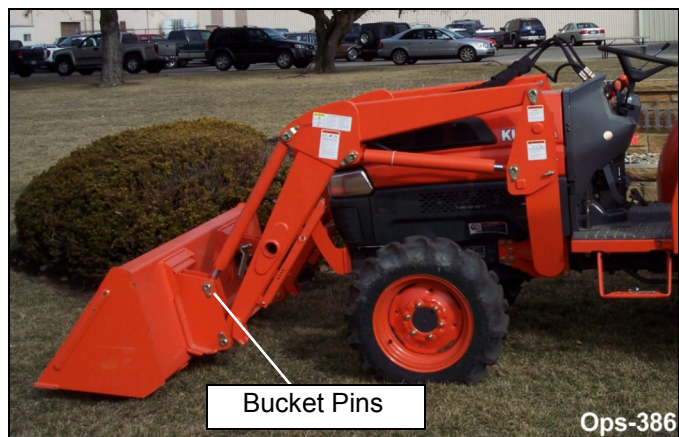

OPERATION

Tractor PRE-OPERATION Inspection



Tractor ID# _____ Make _____

Date _____ Shift _____



Before conducting the inspection, make sure the tractor engine is off, all rotation has stopped and the tractor is in park with the parking brake engaged. Make sure the loader is resting on the ground or securely blocked up and all hydraulic pressure has been relieved.

OPERATION

Item	Condition at Start of Shift	Specific Comments if not O.K.
The flashing lights function properly		
The SMV Sign is clean and visible		
The tires are in good condition with proper pressure		
The wheel lug bolts are tight		
The tractor brakes are in good condition		
The steering linkage is in good condition		
There are no visible oil leaks		
The hydraulic controls function properly		
The ROPS or ROBS Cab is in good condition		
The seatbelt is in place and in good condition		
The 3-point hitch is in good condition		
The drawbar pins are securely in place		
The PTO master shield is in place		
The engine oil level is full		
The brake fluid level is full		
The power steering fluid level is full		
The fuel level is adequate		
The engine coolant fluid level is full		
The radiator is free of debris		
The air filter is in good condition		

Operator's Signature: _____

DO NOT OPERATE an UNSAFE TRACTOR or FRONT END LOADER

OPERATION

FRONT END LOADER PRE-OPERATION Inspection



Front End Loader ID# _____ Make _____

Date _____ Shift _____



Before conducting the inspection, make sure the tractor engine is off, all rotation has stopped and the tractor is in park with the parking brake engaged. Make sure the Loader is resting on the ground or securely blocked up and all hydraulic pressure has been relieved.

OPERATION

Item	Condition at Start of Shift	Specific Comments if not O.K.
The Operator's Manual is in the Canister on the Loader		
All Safety Decals are in place and legible		
The Mounting frame bolts are in place and tight		
The Loader Arms are securely retained in frame mounts		
The Loader connection bolts & pins are tight		
There are no cracks in Loader Arms or Mounts		
The Attachment pins are in place and secure		
The Bucket Quick Attach pins pass through the attachment		
The Bucket Quick Attach control levers are in the lock position		
The Hydraulic Cylinder pins are secured		
The Hydraulic hose connections are tight		
The Hydraulic Valve hose connections are tight		
There are no leaking or damaged hoses		
There is no evidence of Hydraulic leaks		
The Control Valve Lock functions correctly		
The Pivot Pins are properly lubricated		
The Loader Storage Stands are in good condition		

Operator's Signature: _____

DO NOT OPERATE an UNSAFE TRACTOR or FRONT END LOADER

OPERATION

7. Driving the Tractor and Loader



This Implement may be wider than the Tractor. Be careful when operating or transporting this equipment to prevent the Implement from running into or striking sign posts, guard rails, concrete abutments or other solid objects. Such an impact could cause the Implement and Tractor to pivot violently resulting in loss of steering control, serious injury, or even death. Never allow the Implement to contact obstacles. (S3PT-12)



Transport only at speeds where you can maintain control of the equipment. Serious accidents and injuries can result from operating this equipment at high speeds. Understand the Tractor and Implement and how it handles before transporting on streets and highways. Make sure the Tractor steering and brakes are in good condition and operate properly.



Before transporting the Tractor and Implement, determine the proper transport speeds for you and the equipment. Make sure you abide by the following rules:

Test the tractor at a slow speed and increase the speed slowly. Apply the Brakes smoothly to determine the stopping characteristics of the Tractor and Implement. As you increase the speed of the Tractor the stopping distance increases. Determine the maximum transport speed not to exceed 20 mph (30 kph) for transporting this equipment.

Test the equipment at a slow speed in turns. Increase the speed through the turn only after you determine that the equipment can be operated at a higher speed. Use extreme care and reduce your speed when turning sharply to prevent the tractor and implement from turning over. Determine the maximum turning speed for you and this equipment before operating on roads or uneven ground.

Only transport the Tractor and Implement at the speeds which allow you to properly control the equipment.

Be aware of the operating conditions. Do not operate the Tractor with weak or faulty brakes or worn tires. When operating down a hill or on wet or rain slick roads, the braking distance increases: use extreme care and reduce your speed. When operating in traffic always use the Tractor's flashing warning lights and reduce your speed. Be aware of traffic around you and watch out for the other guy. (SG-19)



Your driving vision may be reduced or impaired by the tractor, cab, or implement. Before driving on public roadways identify any limited vision areas, and make adjustments to your operating position, mirrors, and the implement transport position so that you can clearly see the area where you will be traveling, and any traffic that may approach you. Failure to maintain adequate vision of the public roadway and traffic can result in serious injury or even death. (STI-10)

OPERATION



Use extra care when turning or stopping. Allow for increased length and weight of added loader. The loader adds five to six feet of length in front of the tractor and significant weight. Allow extra distance when stopping or turning. Do not allow loader or attachment to contact solid objects. (SL-07)

Safe tractor transport requires the operator possess a thorough knowledge of the model being operated and precautions to take while driving with an attached implement. Ensure the tractor has the capacity to handle the weight of the implement and the tractor operating controls are set for safe transport. To ensure safety while driving the tractor with an attached implement, review the following. OPS-L- 0028

7.1 Starting the Tractor

The procedure to start the tractor is model specific. Refer to the tractor operator's manual for starting procedures for your particular tractor. Consult an authorized dealer if the starting procedure is unclear. Ensure the 3-point control lever is in the lowered position and the PTO is disengaged before starting the tractor. OPS-L-0013



OPERATION

7.2 Brake and Differential Lock Setting



Be aware of the operating conditions. Do not operate the Tractor with weak or faulty brakes. When operating down a hill or on wet or rain slick roads, the braking distance increases; use extreme care and reduce your speed in these conditions. When operating in traffic, always use the Tractor's flashing warning lights and reduce your speed. Be aware of the traffic around you and watch out for the other guy.

Make sure the tractor brakes are in good operating condition. Tractor brakes can be set to operate independently allowing single rear wheel braking action or locked together to provide simultaneous rear wheel braking. FOR MOST DRIVING AND OPERATING CONDITIONS, THE BRAKE PEDALS SHOULD BE LOCKED TOGETHER TO PROVIDE THE MOST EFFECTIVE BRAKING ACTION.

Always disengage the tractor differential lock when turning. When engaged the differential lock will prevent or limit the tractor from turning. During normal working conditions, locking the differential provides no benefit and should not be used. OPS-L- 0015_A



OPERATION

7.3 Driving the Tractor and Loader

Start off driving at a slow speed and gradually increase your speed while maintaining complete control of the tractor and loader. Moving slowly at first will also prevent the tractor from rearing up and loss of steering control. The tractor should never be operated at speeds that cannot be safely handled or which will prevent the operator from stopping quickly during an emergency. If the power steering or engine ceases operating, stop the tractor immediately as the tractor will be difficult to control.

Perform turns with the tractor and loader at slow speeds to determine how the tractor with an attached implements handles a turn. Determine the safe speed to maintain proper control of the tractor when making turns. When turning with an implement, the overall working length of the unit is increased. Allow additional clearance for the loader when turning.

To avoid overturns, drive the tractor with care and at safe speeds, especially when operating over rough ground, crossing ditches or slopes, and turning corners. Tractor rear wheel spacing should be increased when operating on inclines or rough ground to reduce the possibility of tipping.

Use extreme caution when operating on steep slopes. Keep the tractor in a low gear when going downhill. DO NOT coast or free-wheel downhill. OPS-L-0030

7.4 Operating the Tractor and Loader



Do not attempt to lift loads in excess of loader capacity.



Operating loader on a hillside is dangerous. Extreme care is recommended. Keep bucket as low as possible.



Use extreme care when piling material above 6 feet high. Material could shift and fall onto the operator or bystanders. The material could crush or suffocate the operator or bystander resulting in serious injury or death. (SL-17)



Do not raise the loader on a hillside. Do not transport across a slope with a raised loader. When the loader is raised, the center of gravity of the tractor and loader is raised increasing the potential for the tractor to tip over. Tractor wheel contact with any wash out, drop off or the ground obstruction with a raised loader could result in the tractor tipping over and causing serious bodily injury. (SL-21)



Do not operate or raise the loader near the edge of a ditch or where loose soil can give way and allow the tractor to tip over. Keep the tractor tires away from loose soil or the edge of a drop off. Always wear your seatbelt when operating the loader to reduce the possibility of serious injury from a tractor tip over or roll over. (SL-24)

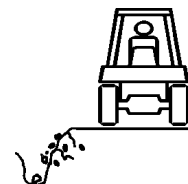

OPERATION



The Boom is designed only to position and operate the Bucket which is attached to it. Never attempt to lift, pull, or push other solid objects with the boom or bucket. Serious injury could result from a structural failure when the Boom is used for purposes other than those for which it was designed. (SBH-9)



Operate the Tractor and/or Implement controls only while properly seated in the Tractor seat with the seat belt securely fastened around you. Inadvertent movement of the Tractor or Implement may cause serious injury or death. (SG-29)



DO NOT operate this Implement on a Tractor that is not properly maintained. Should a mechanical or Tractor control failure occur while operating, immediately shut down the Tractor and perform repairs before resuming operation. Serious injury and possible death could occur from not maintaining this Implement and Tractor in good operating condition. (SG-36)



Do Not operate this equipment in areas where insects such as bees may attack you and/or cause you to lose control of the equipment. If you must enter in such areas, use a tractor with an enclosed Cab and close the windows to prevent insects from entering. If a tractor cab is not available, wear suitable clothing including head, face, and hand protection to shield you from the insects. Attacking insects can cause you to lose control of the tractor, which can result in serious injury or death to you or bystanders. Never dismount a moving tractor. (SG-40)



Keep bystanders 10 feet away from the tractor and loader while operating. The bystanders could enter the path of the tractor or items could fall from the loader resulting in serious injury to the bystander. (SL-01)

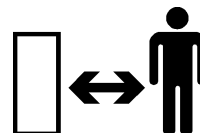

Use extra care when turning or stopping. Allow for increased length and weight of added loader. The loader adds five to six feet of length in front of the tractor and significant weight. Allow extra distance when stopping or turning. Do not allow loader or attachment to contact solid objects. (SL-07)



Do not raise the loader into an overhead structure or allow a raised attachment to contact overhead structures. Sudden or unexpected contact with an overhead structure could result in serious injury. (SL-08)



Do not let the loader or attachment contact electrical power lines. Contact with electrical power lines can result in serious injury or electrocution. If the loader attachment contacts a power line remain in the tractor seat until the power has been shut off. Stepping off the tractor can permit electrical current to pass through the body resulting in electrocution. (SL-09)



OPERATION

⚠️ WARNING

Carry the loader and attachment low when transporting to reduce the potential of the tractor tipping over. Transport on slopes only at slow speeds and use gradual turning angles. Tractor wheel contact with any wash out, drop off or ground obstruction with a raised loader could result in the tractor tipping over and causing serious injury. (SL-12)



⚠️ DANGER

Do not work from the loader or attachments. Do not allow any riders on the loader, tractor or attachments. Falling off the loader could result in serious injury and/or tractor run over. (SL-14)



⚠️ WARNING

Do not use an attachment that is not securely attached to the quick hitch. The attachment could fall resulting in severe crushing injuries or death to the operator or bystanders.



- Rotate both hitch pin levers down to the locked position. You should feel a firm resistance when locking the levers down. The pins must extend through the slots in the bottom of the attachment bracket.
- Examine the fit between the quick hitch and the bottom of the attachment bracket. The pins must extend through the slots in the bottom of the attachment bracket. The tapered side of each pin must be firmly wedged against the surface of the slot on the bottom of the attachment bracket. The attachment bucket should fit snugly against the bottom of the quick hitch bracket. If there is a gap of more than 1/8" or if the pins are not firmly seated do not use the attachment. Contact your dealer before using the attachment.
- On level ground, tilt the attachment down 90° degrees and lower it to the ground. Lower the loader further to slightly raise the front of the tractor off the ground. Drive the tractor in reverse while the attachment is on the ground for 20-30 feet to ensure the attachment does not disconnect. If the attachment disconnects during this process, discontinue the use of the attachment and contact your dealer.

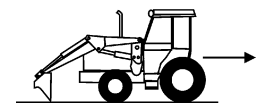
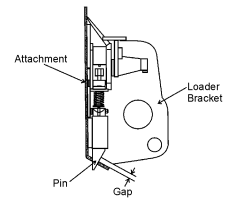
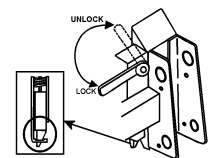

⚠️ WARNING

NEVER walk or work under or allow any person to be underneath a raised loader or attachment. (SL-15)



⚠️ WARNING

Do not operate the loader from the ground. Operate the tractor and loader only while seated in the tractor seat with the seatbelt fastened. The loader could fall crushing a person resulting in serious injury or death. (SL-16)

OPERATION

WARNING

Do not operate the loader from the ground. Operate the tractor and loader only while seated in the tractor seat with the seatbelt fastened. The loader could fall crushing a person resulting in serious injury or death. (SL-16)

WARNING

Use extreme care when piling material above 6 feet high. Material could shift and fall onto the operator or bystanders. The material could crush or suffocate the operator or bystander resulting in serious injury or death. (SL-17)



WARNING

Know before you DIG. Call 888-258-0808 and request that all buried utilities locations be identified before digging in unfamiliar ground. Do not let the loader or attachment contact buried electrical power lines, utilities or gas lines. Contact with electrical power lines can result in serious bodily injury or electrocution. If the loader contacts a power line, remain in the tractor seat until the power has been shut off. Stepping off the tractor can permit electrical current to pass through the body resulting in electrocution. (SL-18)

DANGER

Do not use loader as a jack to raise the tractor tires off the ground. The loader could fail causing the tractor and loader to fall to the ground resulting in serious injury. (SL-25)

WARNING

Use extreme care when loading, transporting or dumping loads that impair or partially block the operator's line of sight. Know where you are traveling. Make sure no bystanders are in the area of travel. If a bystander assists in providing guidance, make sure they are not in the path of travel. Keep all bystanders 25 feet away from travel path. (SL-29)

WARNING

Always look behind you before backing up. Make sure you are looking in the direction of travel. A bystander could walk behind the tractor. Running into a bystander can result in serious injury or death. (SL-30)



WARNING

Some tractors are equipped with a "Super Steer" front axle. When a loader is mounted to this type of tractor, the bucket will shift in the opposite direction from which the wheels are turned. Maximum shift will be approximately 8 inches and most noticeable when the tractor is stationary. Sudden or unexpected movement of the loader and attachment could result in serious injury to the operator or bystanders. (SL-33)

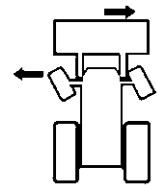

OPERATION

WARNING

Operate the tractor and loader only in conditions where you have clear visibility in daylight or with adequate artificial lighting. Never operate in darkness or foggy conditions where you cannot clearly see at least 100 feet in front and to the sides of the tractor. Make sure you can clearly see bystanders, ditches, steep slopes, drop-offs, overhead obstructions, power lines, and debris or obstruction in the travel path. If you are unable to clearly see these types of items discontinue operating. Contact with unseen vehicles, bystanders, obstructions, or drop-offs can cause serious injury. (SL-35)

WARNING

Never leave the Implement and Power Unit unattended while the Implement is in the raised position. Accidental operation of a lifting lever or a hydraulic failure may cause the implement to suddenly fall causing serious injury or possible death to anyone who might inadvertently be under the Implement. Lower the implement carefully to the ground. Do not put hands or feet under lifted components. (SPU-3)

WARNING

Before dismounting the tractor and loader, lower the loader to the ground or onto solid support blocks. Sudden dropping of the loader and attachment could result in serious injury. (SL-38)

WARNING

Make sure the hydraulic quick disconnects are fully seated into the connections. Do not use the loader if the hydraulic connection is leaking. Leaking oil could allow the loader to fall resulting in a serious crushing injury. (SL-22)

WARNING

If the loader valve controls fail to functions properly discontinue use of the tractor and loader until the controls are properly repaired. Sudden or unexpected movement or dropping of the loader and attachment could result in serious injury. (SL-31)

CAUTION

Make sure all air is purged from the hydraulic system before using the loader. Air in the system can cause the loader to respond sluggishly or with unexpected movement. The air can be purged from the cylinder lines by fully cycling the cylinders several times from the fully closed to fully open position. Sudden or unexpected movement or dropping of the loader and attachment could result in serious injury. (SL-32)

DANGER

Do not raise the loader on a hillside. Do not transport across a slope with a raised loader. When the loader is raised, the center of gravity of the tractor and loader is raised increasing the potential for the tractor to tip over. Tractor wheel contact with any wash out, drop off or the ground obstruction with a raised loader could result in the tractor tipping over and causing serious bodily injury. (SL-21)



OPERATION



Always have a heavy attachment, such as a bucket mounted on loader when it is removed from tractor.



It is important not to put excessive weight on parking stands with lift cylinder retraction. Damage may result.

THE OPERATOR MUST COMPLETELY UNDERSTAND HOW TO OPERATE THE TRACTOR AND IMPLEMENT AND ALL CONTROLS BEFORE ATTEMPTING TO OPERATE. The operator must read and understand the Safety and Operation Sections of the implement and tractor operator's manuals. These manuals must be read and explained to any operator who cannot read. Never allow someone to operate the implement and tractor without complete operating instructions.

Before starting any operation, the operator must become familiar with the area to be worked in and any obstacles and hazards contained within to ensure safety to the operator, bystanders, and equipment. Special attention should be paid to foreign debris, rough terrain, steep slopes, and passersby and animals in the area.
OPS-L-0033

7.5 Operating the Loader

The following text and illustrations offer suggested loader and tractor operating techniques.

FILLING THE BUCKET

Approach and enter the pile with a level bucket.

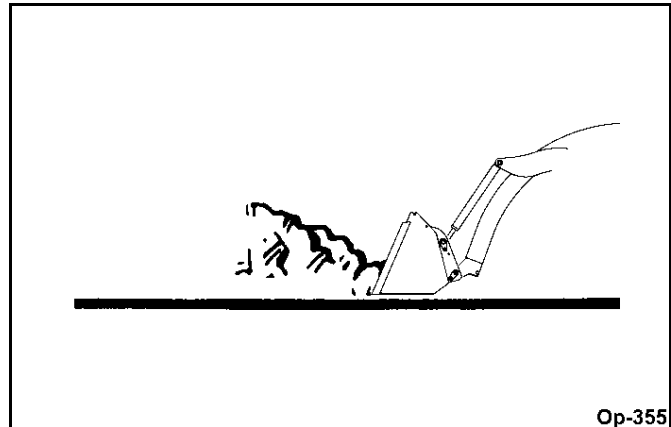

Op-355

OPERATION

OPERATION

Ease lever back toward you to lift and roll back bucket.

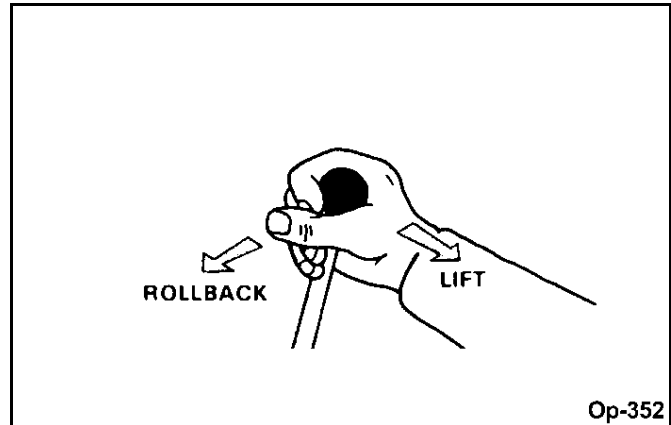

Lift and roll back of bucket will increase efficiency because...

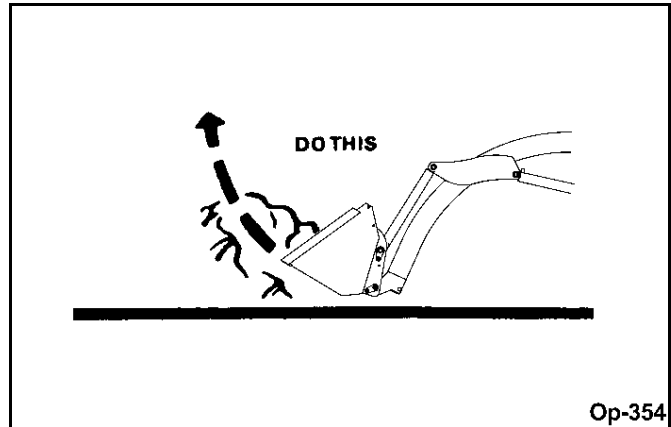

A level bucket throughout the lifting cycle resists bucket lift and increases breakaway effort.

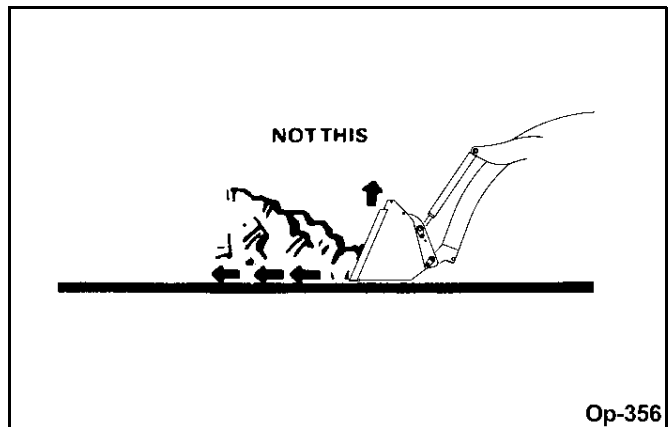

NOTE: Do not be concerned if the bucket is not completely filled during each pass. Maximum productivity is determined by the amount of material loaded in a given period of time. Time is lost if two or more attempts are made to fill the bucket on each pass.

OPERATION

LIFTING THE LOAD

When lifting the load, keep the bucket positioned to avoid spillage. Attachment can be adjusted by using bucket cylinders.

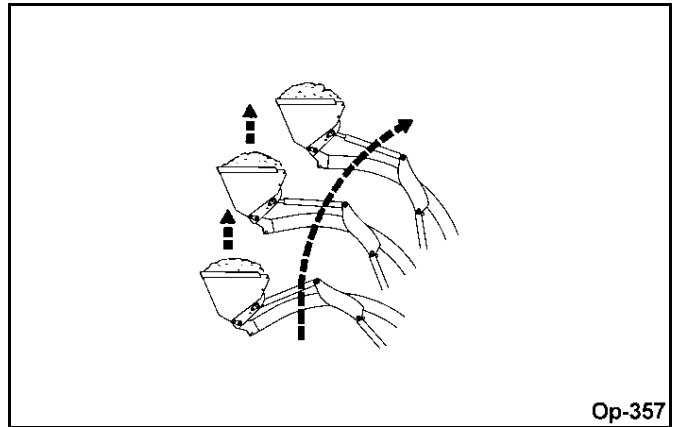

Op-357

CARRYING THE LOAD

Position bucket below tractor hood for maximum stability and visibility, whether bucket is loaded or empty.

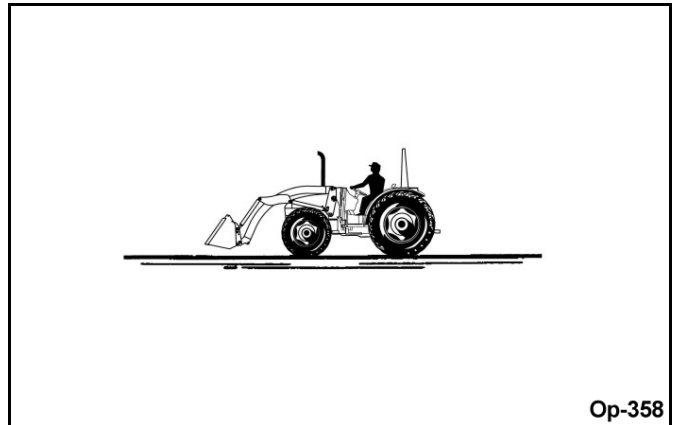

Op-358

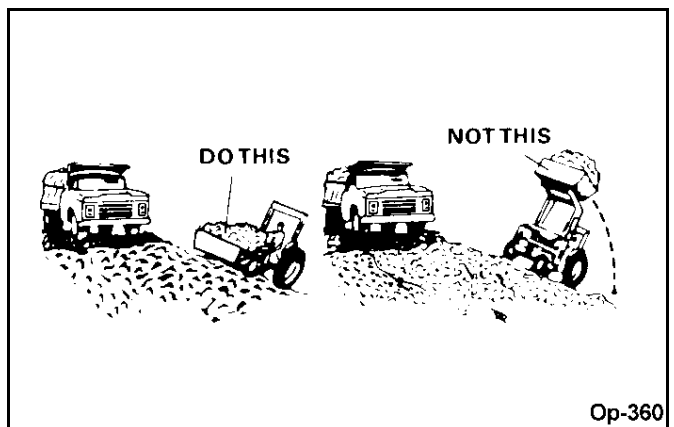

Op-360

OPERATION

OPERATION

Use extreme care when operating loader on a slope, keep bucket as low as possible. This keeps center of gravity low and will provide maximum stability.

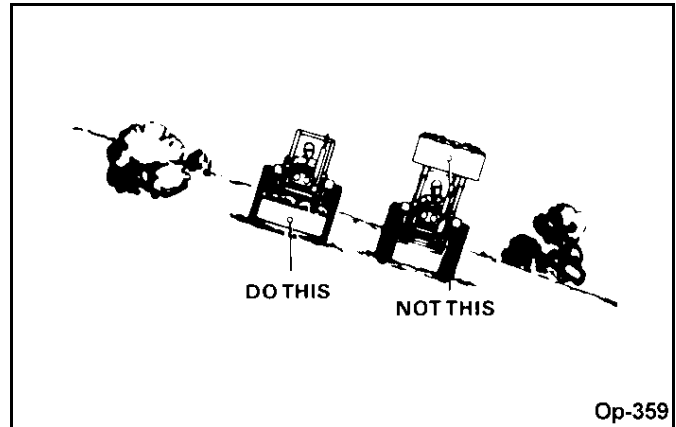

DUMPING THE BUCKET

Lift bucket high enough to clear side of vehicle. Move tractor in as close as possible to side of vehicle, then dump bucket.

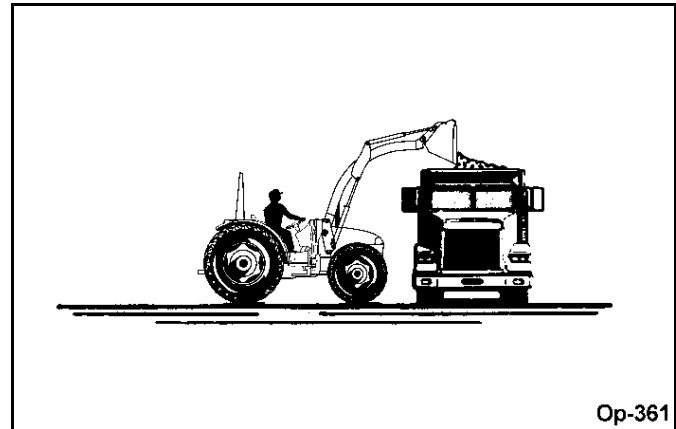

OPERATION

LOWERING THE BUCKET

After bucket is dumped, back away from vehicle while lowering and rolling back bucket.

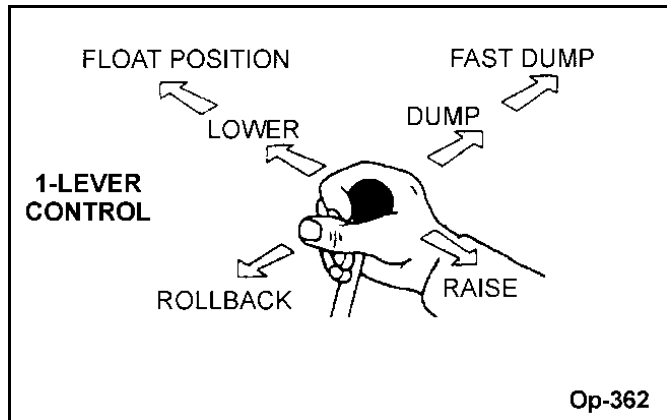

OPERATING WITH FLOAT CONTROL

During hard surface operation, keep bucket level and put lift control in float position to permit bucket to float on working surface. If hydraulic down pressure is exerted on bucket, it will wear faster than normal.

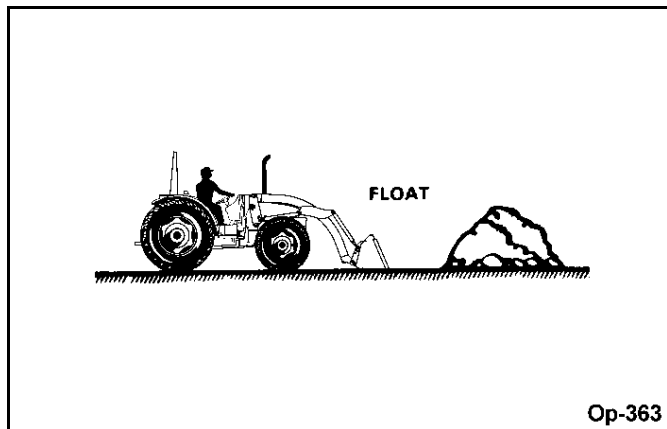

Float will also prevent mixing of surface material with stockpile material. Float position will reduce the chance of surface gouging when removing snow or other material.

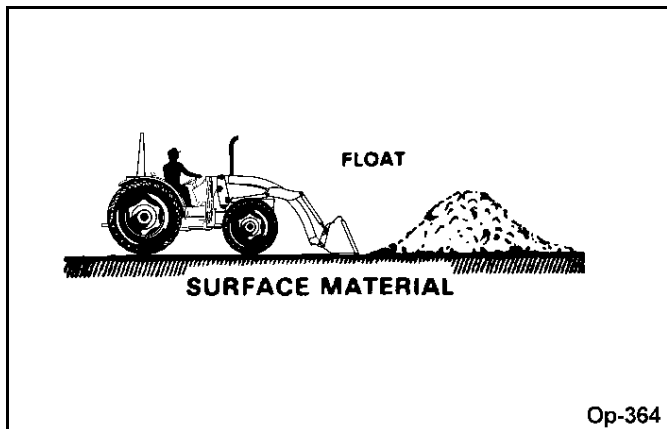

OPERATION

OPERATION

LOADING FROM A BANK

Choose a forward gear that provides sufficient ground speed for loading.

Exercise caution when undercutting high banks. Dirt slides can be dangerous. Load from as low as possible for maximum efficiency. Loader lift and breakaway capacity diminish as loading height is increased.

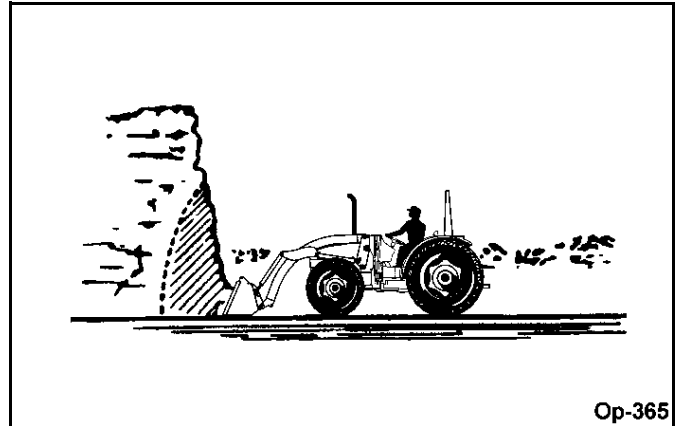

Op-365

Side cutting is a good technique for cutting down a big pile.

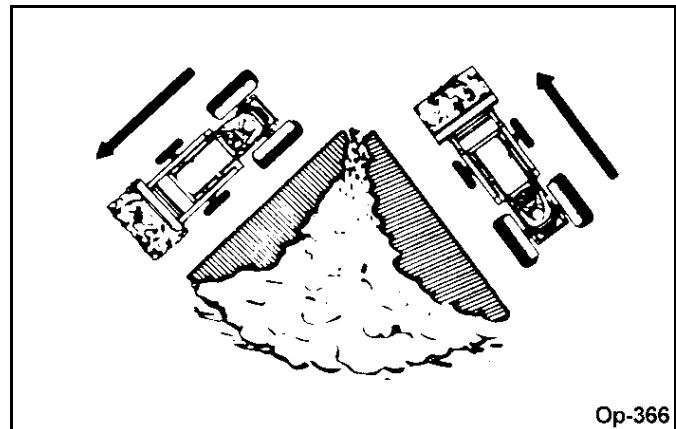

Op-366

If the pile sides are too high and liable to cause cave-in, use loader to break down the sides until a slot can be cut over the top.

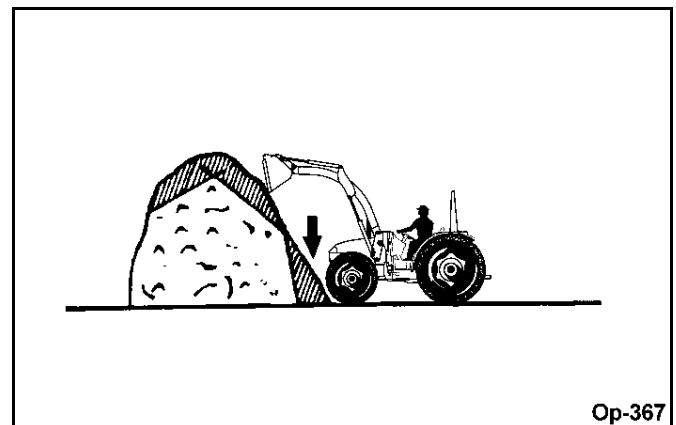

Op-367

OPERATION

Another method for large dirt piles is to build a ramp approach to the pile.

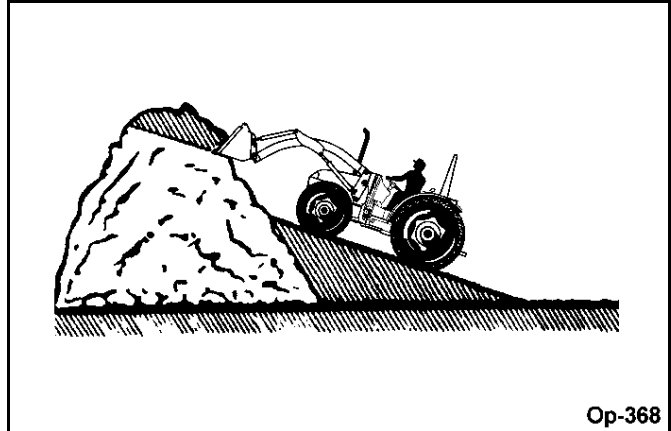

It is important to keep the bucket level when approaching a bank or pile. This will help prevent gouging the work area.

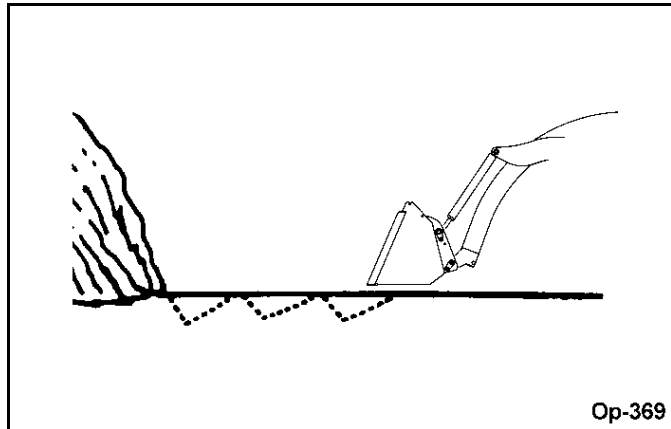

OPERATION

OPERATION

OPERATION

PEELING AND SCRAPING

Use a slight bucket angle, travel forward and hold lift control forward to start the cut. Make a short angle cut and break out cleanly.

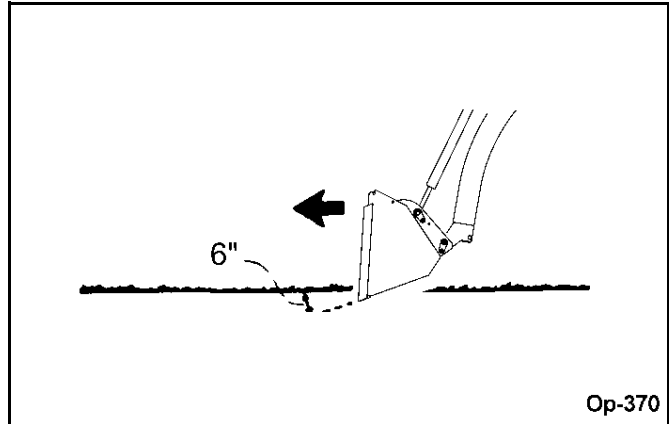

With bucket level, start a cut at notch approximately 2 inches deep. Hold depth by feathering bucket control to adjust cutting lip up or down. When front tires enter the notch, adjust lift cylinder to maintain proper depth.

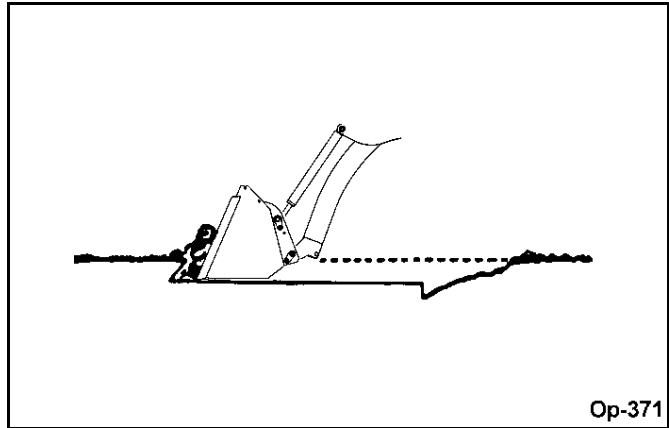

Make additional passes until desired depth is reached. During each pass, use only bucket control while working depth. This will allow you to concentrate on controlling bucket angle to maintain a precise cut.

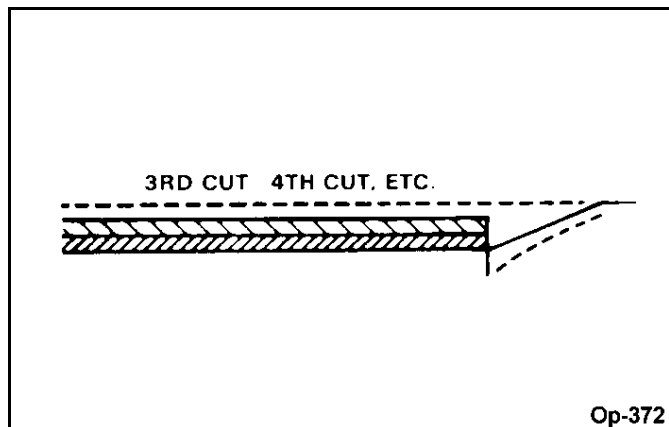

OPERATION

LOADING LOW TRUCKS OR SPREADERS FROM A PILE

For faster loading, minimize angle of turn and length of run between pile and spreader. Back grade occasionally with a loaded bucket to keep working surface free of ruts and holes. Also, hold lift control forward so full weight of bucket is scraping ground.

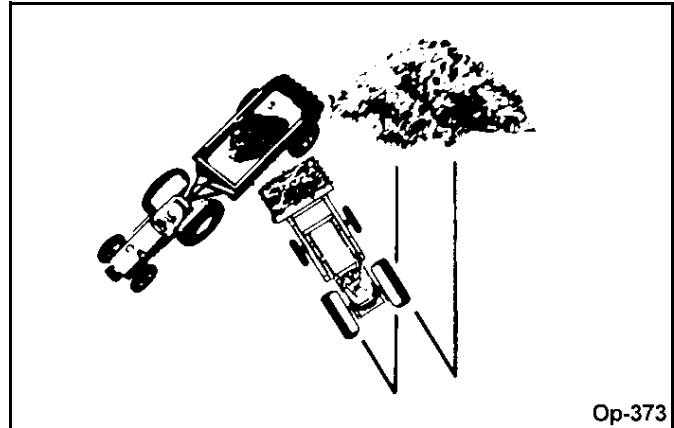

Do not roll bucket over and attempt to backgrade. This type of use can cause severe overloading of bucket cylinders when fully extended, possibly causing bucket cylinder rods to become bent. Back grade occasionally with loaded bucket to eliminate ruts and holes. Use the heel of the bucket by holding down pressure of the lift cylinder.

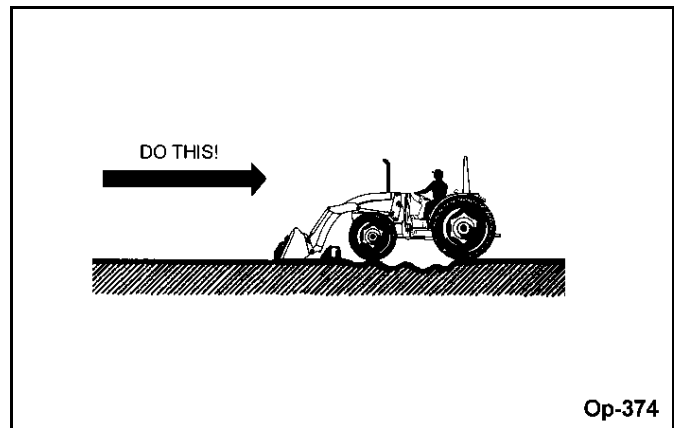

Approach pile with a level bucket.

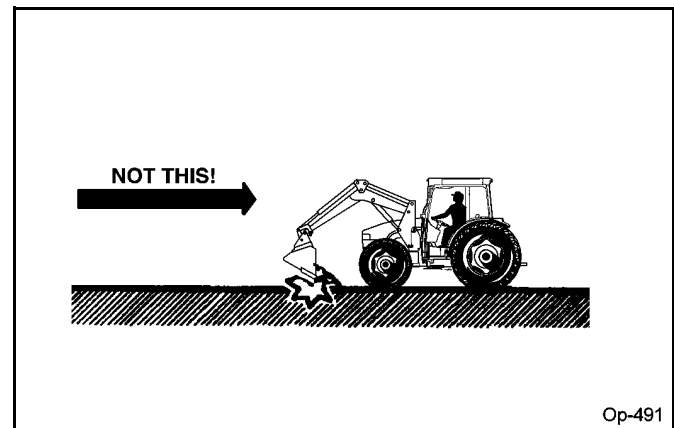

OPERATION

BACKFILLING

Poor methods actually move no more dirt and make it more difficult to hold a level grade.

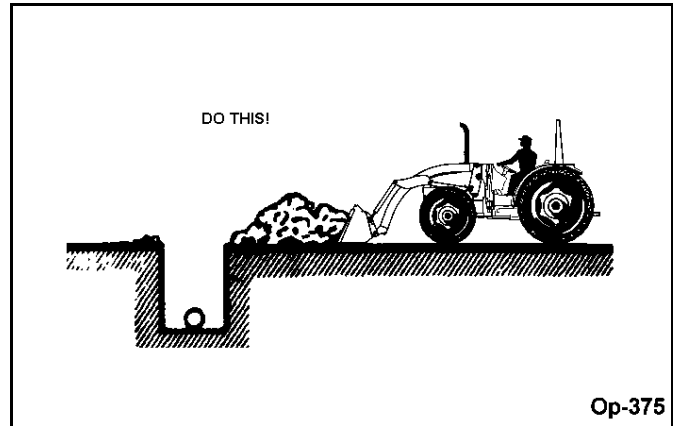

Do not use bucket in dumped position for bulldozing. This method, shown above, will impose severe shock loadings on dump linkage, bucket cylinder and tractor.

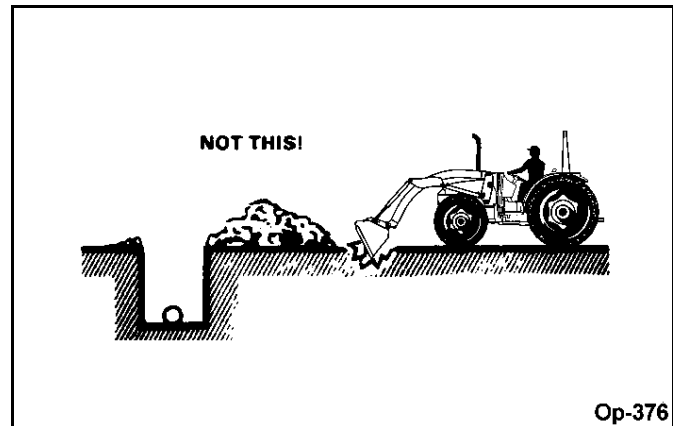

OPERATION

Leave dirt in bucket. Dumping on each pass wastes time.

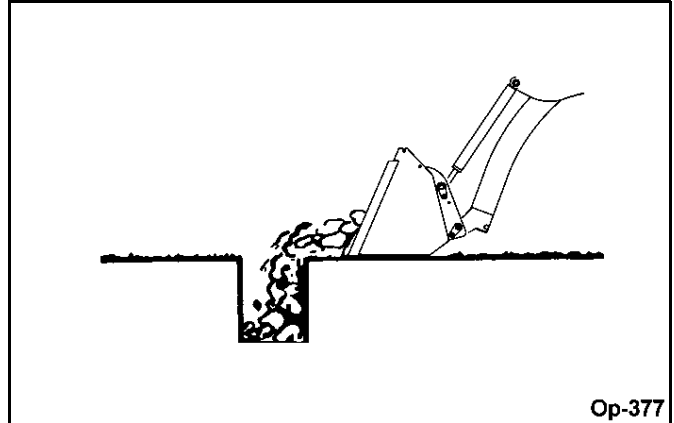

Operate tractor at right angles to ditch. Take as big a bite as tractor can handle without lugging down.

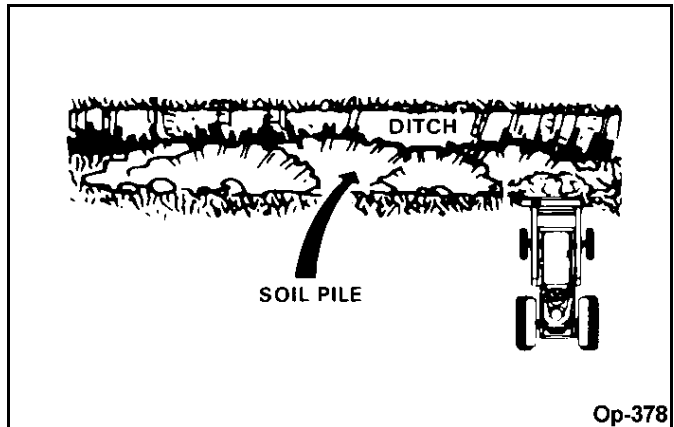

OPERATION

OPERATION

OPERATION

Leave dirt which drifts over side of bucket for final cleanup.

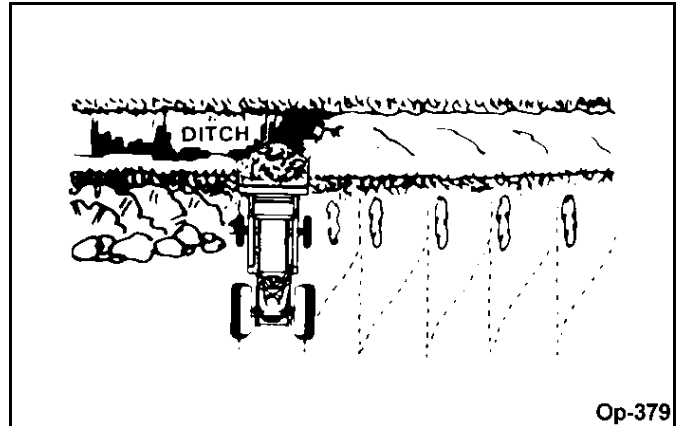

Pile dirt on high side for easier backfilling on a slope.

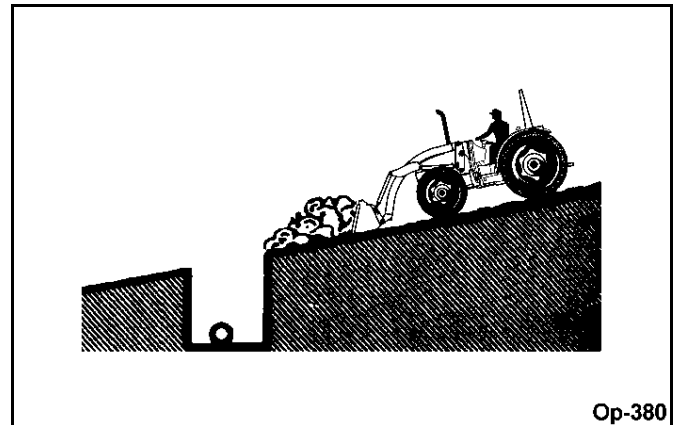

HANDLING LARGE HEAVY OBJECTS

1. Using front end loaders for handling large heavy objects such as large round or rectangular bales, logs and oil drums is not recommended.
2. Handling large heavy objects can be extremely dangerous due to:
 - Danger of tractor rolling over.
 - Danger of up-ending tractor.
 - Danger of object rolling or sliding down loader arms onto operator.
3. If you must perform above work, protect yourself by:
 - Never lifting load higher than necessary to clear ground when moving.
 - Ballasting tractor rear to compensate for load.
 - Never lifting large objects with equipment that does not have an anti-rollback device.
 - Moving slowly and carefully, avoiding rough terrain.
 - Tilt bucket forward while lifting to maintain bucket angle.

OPERATION

7.6 Operating Bale Spear



Operate the bale spear using extreme caution. Sharp points on bale spear can cause serious injury or death.



Because of size and weight of large bales, extreme care must be taken in handling them. Be aware of forces acting on stacked bales due to gravity and keep workers far from zones of potential hazard from shifting or falling bales. **DO NOT ALLOW BYSTANDERS!**



Keep bystanders 10 feet away from the tractor and loader while operating. The bystanders could enter the path of the tractor or items could fall from the loader resulting in serious injury to the bystander. (SL-01)

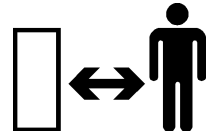

Keep bale spear and loader boom clear of overhead lines. Allowing loader boom or any attachments to contact overhead power lines may electrify entire tractor and electrocute (kill) operator.



Store the grapple bucket or bale spear attachment with the point(s) on the ground. Walking into the point of the bale or grapple spear can cause serious bodily injury. Never drive the bale spear or grapple bucket attachment forward if a bystander is in front of the loader. (SL-10)

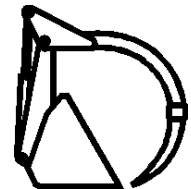

Loader equipped with bale spear is designed to handle round bales up to 2000 pounds.

Load bale spear by approaching from round end to prevent cutting strings or puncturing plastic or net wrap. Tilt bale spear upward to prevent bale from falling off of spear,

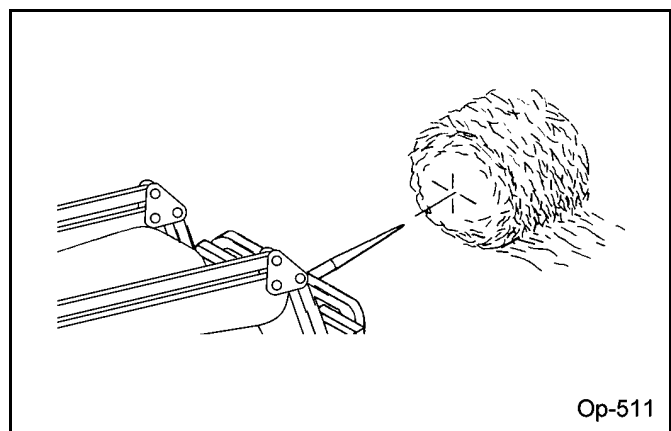

OPERATION

Carry bales as low to the ground as possible to allow maximum visibility and avoid tipping.

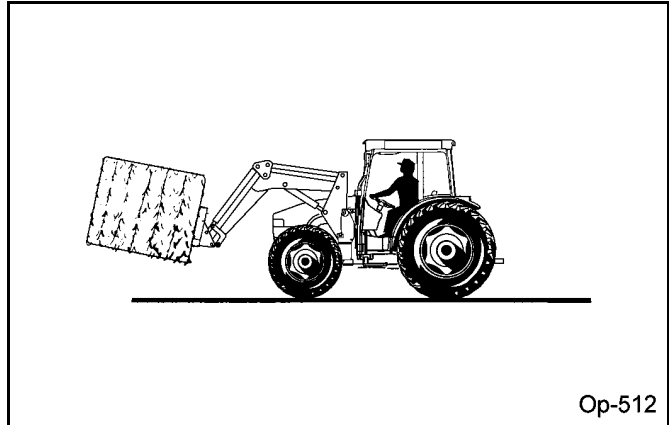

OPERATION

7.7 Valve Lock

WARNING

Before transporting the tractor and Loader engage the loader valve travel lock to prevent inadvertent contact with the joystick controller causing sudden dropping of the loader and attachment. If the loader attachment, such as a bucket, were to drop suddenly and hit the ground while transporting, the tractor could stop immediately resulting in the operator hitting the steering wheel or flying out of the operator's seat. Serious injury could result. (SL-04)



CAUTION

To avoid injury from crushing, do not utilize the valve lock for machine maintenance or repair. The valve lock is designed to prevent accidental actuation when the loader is not in use or during transport.

WARNING

To avoid injury during installation of loader, do not allow bystanders within 10 feet of loader or attachment.

WARNING

Always have a heavy attachment, such as a bucket mounted on loader when it is removed from tractor.

WARNING

It is important not to put excessive weight on parking stands with lift cylinder retraction. Damage may result.

OPERATION

The tractor is equipped with a valve lock mechanism located between the operator and control valve as shown. This feature allows the control valve to be locked during transport or when the loader is not in use to prevent accidental actuation of the control valve and loader cylinders.

To activate the lock, push the lever away from the operator, slide lever down then pull lever in towards operator.

To release the lock mechanism, push the lever away from the operator, slide lever up then pull lever in towards operator.

The lock is not intended to, and will not prevent leak down of the loader hydraulics during storage.



8. Loader Storage



Never allow children to play on or around Tractor or Implement. Children can slip or fall off the Equipment and be injured or killed. Inadvertent contact with controls can cause the Implement to shift or fall crushing themselves or others. (SG-25)

Properly preparing and storing the loader at the end of the season is critical to maintaining its appearance and to help ensure years of dependable service. The following are suggested storage procedures:

- Thoroughly clean all debris off the loader to prevent damage from rotting grass and standing water.
- Lubricate all grease points detailed in the maintenance section.
- Tighten all bolts and pins to the recommended torque.
- Check worn and damaged parts. Perform repairs and make replacements immediately so that the loader will be ready for use at the start of the next season.
- Store the loader in a clean, dry place resting securely on parking stands at ground level.
- Use spray touch-up enamel where necessary to prevent rust and maintain the appearance of the loader. OPS-L-0010_B



OPERATION

9. Transporting the Tractor and Implement



Never allow children or other persons to ride on the Tractor or Implement. Falling off can result in serious injury or death. (SG-10)



Transport only at speeds where you can maintain control of the equipment. Serious accidents and injuries can result from operating this equipment at high speeds. Understand the Tractor and Implement and how it handles before transporting on streets and highways. Make sure the Tractor steering and brakes are in good condition and operate properly.



Before transporting the Tractor and Implement, determine the proper transport speeds for you and the equipment. Make sure you abide by the following rules:

Test the tractor at a slow speed and increase the speed slowly. Apply the Brakes smoothly to determine the stopping characteristics of the Tractor and Implement. As you increase the speed of the Tractor the stopping distance increases. Determine the maximum transport speed not to exceed 20 mph (30 kph) for transporting this equipment.

Test the equipment at a slow speed in turns. Increase the speed through the turn only after you determine that the equipment can be operated at a higher speed. Use extreme care and reduce your speed when turning sharply to prevent the tractor and implement from turning over. Determine the maximum turning speed for you and this equipment before operating on roads or uneven ground.

Only transport the Tractor and Implement at the speeds which allow you to properly control the equipment.

Be aware of the operating conditions. Do not operate the Tractor with weak or faulty brakes or worn tires. When operating down a hill or on wet or rain slick roads, the braking distance increases: use extreme care and reduce your speed. When operating in traffic always use the Tractor's flashing warning lights and reduce your speed. Be aware of traffic around you and watch out for the other guy. (SG-19)



Before transporting the tractor and Loader engage the loader valve travel lock to prevent inadvertent contact with the joystick controller causing sudden dropping of the loader and attachment. If the loader attachment, such as a bucket, were to drop suddenly and hit the ground while transporting, the tractor could stop immediately resulting in the operator hitting the steering wheel or flying out of the operator's seat. Serious injury could result. (SL-04)

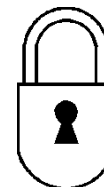

OPERATION

WARNING

Lower the loader to the bed of the truck or trailer when transporting the tractor and loader with a truck. Measure to ensure the transport height does not exceed the legal limits. Contact with overhead obstructions or power lines can cause property damage or serious injury. (SL-34)

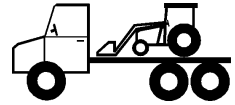

WARNING

In case of mechanical difficulty during operation, place the transmission in the park position, set the parking brake, shut down all power, including the PTO and the engine and remove the key. Wait until all rotating motion has stopped before dismounting. (SG-39)

Inherent hazards of operating the tractor and implement and the possibility of accidents are not left behind when you finish working in an area. Therefore, the operator must employ good judgement and safe operation practices when transporting the tractor and implement between locations. By using good judgement and following safe transport procedures, the possibility of accidents while moving between locations can be substantially minimized. OPS-L-0031

Before transporting the tractor and loader, idle the tractor engine. When transporting, carry the loader as low as possible maintaining adequate ground clearance and visibility. Reduce tractor ground speed when transporting a load. Take extra care when traveling over rough terrain or on slopes. OPS-L-0011



Op-37

Before transporting the tractor on a public roadway or boarding a trailer for transport, the tractor brake pedals should be locked together. Locking the pedals ensures that both wheels brake simultaneously while stopping, especially when making an emergency stop.

Use extreme caution and avoid hard applications of the tractor brakes when towing heavy loads at road speeds. Never tow the implement at speeds greater than 20 MPH (32 kph). OPS-U-0018

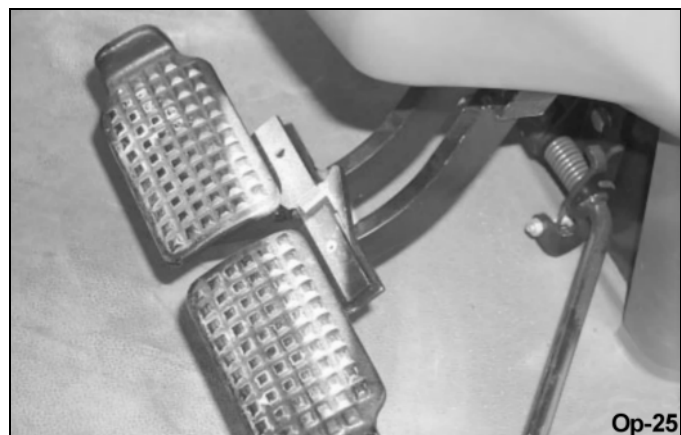

Op-25

OPERATION

9.1 Transporting on Public Roadways



Make certain that the “Slow Moving Vehicle” (SMV) sign is installed in such a way as to be clearly visible and legible. When transporting the Equipment use the Tractor flashing warning lights and follow all local traffic regulations. (SG-6)

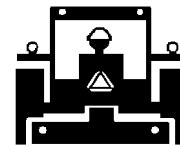

Extreme caution should be used when transporting the tractor and implement on public roadways. The tractor must be equipped with all required safety warning features including a SMV emblem and flashing warning lights to alert drivers of the tractor’s presence. Remember that roadways are primarily designed for automotive drivers and most drivers will not be looking out for you, therefore, you must look out for them. Check your side view mirrors frequently and remember that vehicles will approach quickly because of the tractor’s slower speed. Be extremely cautious when the piece of equipment that you are towing is wider than the tractor tire width and/or extends beyond your lane of the road. OPS-L- 0032

OPERATION

The SMV (Slow-Moving Vehicle) emblem is universal symbol used to alert drivers of the presence of equipment traveling on roadways at a slow speed. SMV signs are a triangular bright orange with reflective red trim for both easy day and night visibility. Make sure the SMV sign is clean and visible from the rear of the unit before transporting the tractor and implement on a public roadway. Replace the SMV emblem if faded, damaged, or no longer reflective. OPS-U- 0020



Op-43

Make sure that all tractor flashing warning lights, headlights, and brake/tail lights are functioning properly before proceeding onto public roads. While newer model tractors have plenty of lighting to provide warning signals and operating lighting, most older models are only equipped with operating lights. Consult an authorized tractor dealer for lighting kits and modifications available to upgrade the lighting on older tractor models. OPS-U- 0021



Op-595

When operating on public roads, have consideration for other road users. Pull to the side of the road occasionally to allow all following traffic to pass. Do not exceed the legal speed limit set in your country for agricultural tractors. Always stay alert when transporting the tractor and implement on public roads. Use caution and reduce speed if other vehicles or pedestrians are in the area. OPS-L- 0020

OPERATION

9.2 Hauling the Tractor and Implement

Before transporting a loaded tractor and implement, measure the height and width dimensions and gross weight of the complete loaded unit. Ensure that the load will be in compliance with the legal limits set for the areas that will be traveled through. *OPS-U- 0024*



Use adequately sized and rated trailers and equipment to transport the tractor and implement. Consult an authorized dealer to determine the proper equipment required. Using adequately sized chains, heavy duty straps, cables and/or binders, securely tie down both the front and rear of the tractor utilizing the proper tie down locations as specified by the tractor manufacturer. *OPS-U- 0025*



OPERATION

OPERATION

10. Troubleshooting Guide

TROUBLE	POSSIBLE CAUSE	POSSIBLE REMEDY
Loader slow or will not lift and/or dump	Hydraulic oil too heavy.	Change to proper oil.
	Oil filter plugged. Hydraulic pump worn. Oil line restricted or leaking.	Clean or replace filter. Repair or replace pump. Check all hoses and tubes for leaks, damage or restrictions. Replace damaged or restricted hoses or tube oil lines.
	Control valve does not shift properly. Air in hydraulic system.	Inspect, clean, repair or replace valve. Cycle lift cylinders and bucket cylinders several times to free system of air.
	Cylinder leaks internally. Faulty relief valve (tractor).	Replace seals. Clean and replace relief valve.
Loader chatters or vibrates when raising or lowering	Air leak in pump inlet line.	Check, tighten or replace inlet line.
	Air in hydraulic system. Oil level too low.	Cycle lift and bucket cylinders. Add oil as required.
External leakage	Damaged seals.	Remove leaking component; replace seals.
Pump noisy	Inlet line restricted or leaking.	Check for air leaks, restrictions or collapsed hose. Tighten or replace hose. Clean filter.
	Oil level too low. Pump worn or damaged.	Add oil as required. Repair or replace pump.
Excessive wear on bucket cutting edge	Bucket is riding on cutting edge instead of wear runners.	Use boom "FLOAT" position or bucket level indicator to ensure bucket rides on wear runners.

MAINTENANCE SECTION

MAINTENANCE

READ, UNDERSTAND, and FOLLOW the following Safety Messages. Serious injury or death may occur unless care is taken to follow the warnings and instructions stated in the Safety Messages. Always use good common sense to avoid hazards. (SG-2)



Never interfere with factory-set hydraulic calibrations. Any change in calibration could cause a failure of the equipment and may result in injury. (SBH-13)



Always maintain the safety signs in good readable condition. If the safety signs are missing, damaged, or unreadable, obtain and install replacement safety signs immediately. (SG-5)



Make certain that the "Slow Moving Vehicle" (SMV) sign is installed in such a way as to be clearly visible and legible. When transporting the Equipment use the Tractor flashing warning lights and follow all local traffic regulations. (SG-6)

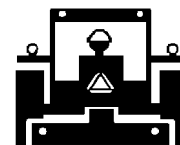

Do not modify or alter this Implement. Do not permit anyone to modify or alter this Implement, any of its components or any Implement function. (SG-8)



Never work under the Implement, the framework, or any lifted component unless the Implement is securely supported or blocked up to prevent sudden or inadvertent falling which could cause serious injury or even death. (SL-36)



Do not operate this Equipment with hydraulic oil or fuel leaking. Oil and fuel are explosive and their presence could present a hazard. Do not check for leaks with your hand! High-pressure oil streams from breaks in the line could penetrate the skin and cause tissue damage including gangrene. To check for a hose leak, SHUT the unit ENGINE OFF and remove all hydraulic pressure. Wear oil impenetrable gloves, safety glasses and use Cardboard to check for evidence of oil leaks. If you suspect a leak, REMOVE the HOSE and have it tested at a Dealer. If oil does penetrate the skin, have the injury treated immediately by a physician knowledgeable and skilled in this procedure. (SG-15)



Never attempt to lubricate, adjust, or remove material from the Implement while it is in motion or while tractor engine is running. (SG-20)

MAINTENANCE



Do Not fill fuel tank while engine is running. Refuel only after engine has cooled down. If fuel is spilled, move machine away from the area of the spill and avoid creating any source of ignition until the fuel has evaporated. (SBH-49)



Avoid contact with hot surfaces including hydraulic oil tanks, pumps, motors, valves and hose connections. Relieve hydraulic pressure before performing maintenance or repairs. Use gloves and eye protection when servicing hot components. Contact with a hot surface or fluid can cause serious injury from burns or scalding. (SG-34)



Use caution and wear protective gloves when handling sharp objects such as blades, knives, and other cutting edges. Be alert to worn component surfaces which have sharp edges. Sharp surfaces can inflict severe laceration injuries if proper hand protection is not worn. (SG-37)



Avoid contact with hot surfaces of the engine or muffler. Use gloves and eye protection when servicing hot components. Contact with a hot surface or fluid can cause serious injury from burns or scalding. (SG-38)



Never allow anyone to get under the loader or attachment or to reach through the loader lift arms when raised. Serious injury could result from crushing or pinching by the loader or attachment. (SL-06)



NEVER perform maintenance beneath a raised loader unless loader is properly supported to prevent accidental lowering.

PARTS INFORMATION

Rhino products are designed utilizing specifically matched system components to ensure optimum equipment performance. These parts are made and tested to Rhino specifications. Non-genuine "will fit" parts do not consistently meet these specifications. The use of "will fit" parts may reduce equipment performance, void warranties, and present a safety hazard. Use genuine Rhino parts for economy and safety. (SPRM-2)

SEE YOUR RHINO DEALER

MAINTENANCE

MAINTENANCE

Lubrication Schedule

Before operating your Loader, take the time to inspect and repair any damage to the machine or tractor. Only a minimum of time and effort is required to regularly maintain this machine to provide long life and trouble free operation.

MAINTENANCE

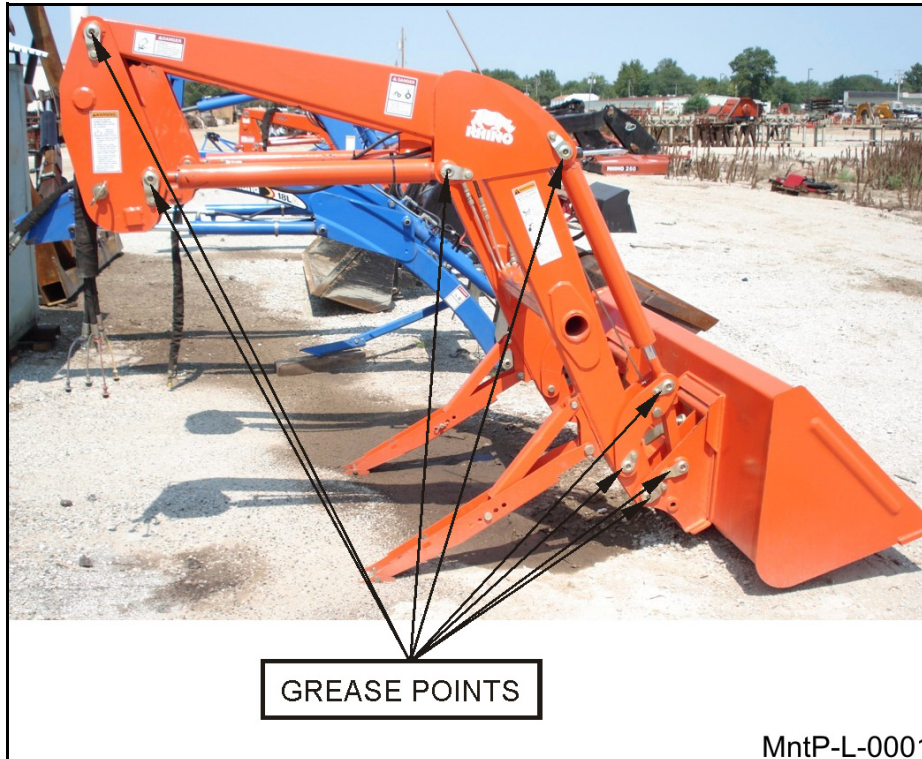

Lubricate all grease fittings: one at each end of lift boom arms and one at rod and base ends of each lift and bucket cylinders.

NOTE: Fully retract bucket to a comfortable height to grease bucket/loader boom joint. Do not reach or stand under a raised loader or attachment without proper support.

MAINTENANCE

Daily Maintenance

Regular maintenance of your loader and hydraulic system will insure maximum loader efficiency and long life.

1. Check fluid level of tractor hydraulic system before starting each day's operation. If necessary, add hydraulic oil as recommended in your tractor operator's manual.
2. After every four hours of operation, lubricate all sixteen grease fittings
3. After every ten hours of operation, check all hardware and tighten where required.
4. Replace hoses immediately if they are damaged by a cut or scrape, extruded at the fittings or leaking. Hydraulic oil leaks should be repaired promptly to avoid loss of oil and serious personal injury from escaping oil.

⚠ WARNING

Escaping hydraulic fluid under pressure can penetrate skin, causing serious personal injury.

- DO NOT use your hand to check for leaks. Use a piece of wood or cardboard and wear eye protection to search for leaks.
- Stop engine and relieve pressure before connecting or disconnecting lines.
- Tighten all connections before starting engine or pressurizing lines.

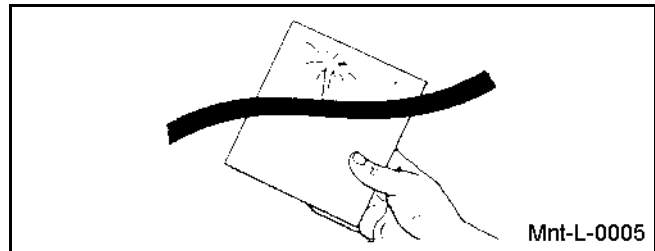

NOTE: If any fluid is injected into skin, obtain medical attention immediately or gangrene may result.

MAINTENANCE

Storage



Never crawl under or allow children to play around or on a loader that is disconnected from the tractor. The loader could fall crushing a person resulting in serious injury or death. (SL-13)



Do not remove the attachment from the loader when the loader is disconnected from the tractor. The attachment stabilizes the loader. If the attachment is removed, the loader will fall and could result in serious injury. (SL-26)



Only disconnect and store the loader on firm flat ground. Make sure the loader stands are properly installed and rest on firm ground or support blocks. If the stands sink or fail, the loader could fall causing serious injury. (SL-27)

NOTE: When loader hydraulics are disconnected from tractor, the tractor hydraulic circuit must be completed. Failure to do so will result in tractor hydraulic pump damage.

1. Store loader with attachment securely attached.

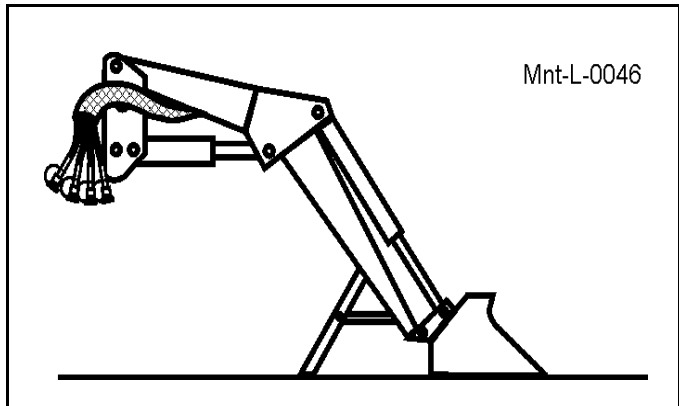

2. Place dust caps on hydraulic quick couplers.

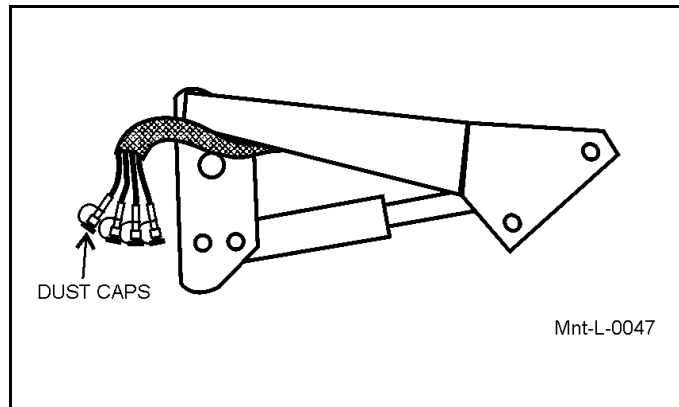

MAINTENANCE

3. Do not remove attachment from stored loader.

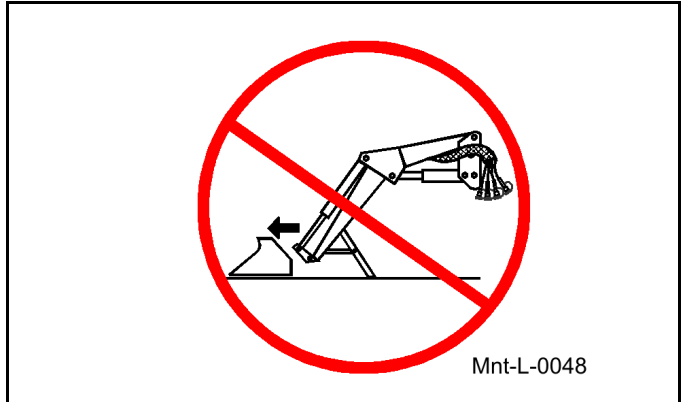

4. Do not allow children to play on or around loader.



MAINTENANCE

MAINTENANCE



MAINTENANCE

Proper Torque for Fasteners

The chart lists the correct tightening torque for fasteners. When bolts are to be tightened or replaced, refer to this chart to determine the grade of bolts and the proper torque except when specific torque values are assigned in manual text.

RECOMMENDED TORQUE IN FOOT POUNDS UNLESS OTHERWISE STATED IN THE MANUAL*





NOTE: These values apply to fasteners as received from supplier, dry or when lubricated with normal engine oil. They do not apply if special graphited or molydisulphide greases or other extreme pressure lubricants are used. This applies to both UNF fine and UNC coarse threads.

AMERICAN STANDARD CAP SCREWS								
SAE Grade	5				8			
CAP SCREW SIZE								
	TORQUE				TORQUE			
	FT-LBS		Nm		FT-LBS		Nm	
Inches	MIN	MAX	MIN	MAX	MIN	MAX	MIN	MAX
1/4 - 20	6.25	7.25	8.5	10	8.25	9.5	11	13
1/4 - 28	8	9	11	12	10.5	12	14	18
5/16 - 18	14	15	19	20	18.5	20	25	27
5/16 - 24	17.5	19	23	26	23	25	31	34
3/8 - 16	26	26	35	38	35	37	47.5	50
3/8 - 24	31	34	42	46	41	45	55.5	61
7/16 - 14	41	45	55	61	55	60	74.5	81
7/16 - 20	51	55	69	74	68	75	92	102
1/2 - 13	66	72	88	97	86	96	116	130
1/2 - 20	76	84	103	114	102	112	138	152
9/16 - 12	95	105	129	142	127	140	172	190
9/16 - 18	111	123	150	167	148	164	200	222
5/8 - 11	126	139	171	188	168	185	228	251
5/8 - 18	152	168	206	228	203	224	275	304
3/4 - 10	238	262	322	355	318	350	431	474
3/4 - 16	274	305	371	409	365	402	495	544
7/8 - 9	350	386	474	523	466	515	631	698
7/8 - 14	407	448	551	607	543	597	736	809
1 - 8	537	592	726	802	716	790	970	1070
1 - 14	670	740	908	1003	894	987	1211	1337

Mnt-L-0003_A

MAINTENANCE

MAINTENANCE

METRIC CAP SCREWS								
METRIC CLASS CAP SCREW SIZE	8.8				10.9			
								
	TORQUE				TORQUE			
	FT-LBS		Nm		FT-LBS		Nm	
Millimeters	MIN	MAX	MIN	MAX	MIN	MAX	MIN	MAX
M6 X 1.00	6	8	8	11	9	11	12	15
M8 X 1.25	16	20	21.5	27	23	27	31	36.5
M8 X 1.00	16	20	22	27	23	27	31	37
M10 X 1.50	29	35	39	47	42	52	57	70
M10 X 1.25	31	37	42	50	43	53	58	72
M12 X 1.75	52	62	70	84	75	91	102	123
M12 X 1.25	56	66	76	89	80	96	108	130
M14 X 2.00	85	103	115	139	120	146	163	196
M14 X 1.50	91	109	123	148	127	153	172	207
M16 X 2.50	130	158	176	214	176	216	238	293
M16 X 1.50	137	165	186	224	183	223	248	302
M18 X 2.50	172	210	233	284	240	294	325	398
M18 X 1.50	194	232	263	315	266	320	360	434
M20 X 2.50	247	301	335	408	343	425	465	577
M20 X 1.50	273	327	370	443	378	462	512	626
M22 X 2.50	332	404	450	547	472	576	639	780
M22 X 1.50	358	434	485	588	513	617	695	836
M24 X 3.00	423	517	573	700	599	732	812	992
M24 X 2.00	457	551	620	747	628	761	851	1032
M27 X 3.00	637	779	863	1055	898	1098	1217	1488
M30 X 3.00	872	1066	1181	1444	1224	1496	1658	2027

Mnt-L-0003_B

MAINTENANCE

MAINTENANCE

Torque Specifications for 37° JIC Fittings

ASSEMBLY TORQUE					
Size	Thread Size	IN-LBS	FT-LBS	Tube Connection F.F.F.T.	Swivel Nut or Hose Connection F.F.F.T.
-4	7/16 - 20	140 ± 10	12 ± 1	2	2
-5	½ - 20	180 ± 15	15 ± 1	2	2
-6	9/16 - 18	250 ± 15	21 ± 1	1-1/2	1-1/4
-8	¾ - 16	550 ± 25	45 ± 5	1-1/2	1
-12	1-1/16 - 12	1000 ± 50	85 ± 5	1-1/4	1
-16	1-5/16 - 12	1450 ± 50	120 ± 5	1	1
-20	1-5/8 - 12	2000 ± 100	170 ± 10	1	1
-24	1-7/8 - 12	2400 ± 150	200 ± 15	1	1
-32	2-1/2 - 12	3200 ± 200	270 ± 20	1	1

Mnt-L-0003_C

Torque Specifications for SAE O-ring Fittings

ASSEMBLY TORQUE				
Size	Thread Size	IN-LBS	FT-LBS	F.F.F.T.
2	5/16 - 24	90 ± 5	7.5 ± 0.5	1 ± 0.25
3	3/8 - 24	170 ± 10	14 ± 1	1 ± 0.25
4	7/16 - 20	220 ± 15	18 ± 1	1 ± 0.25
5	½ - 20	260 ± 15	22 ± 1	1 ± 0.25
6	9/16 - 18	320 ± 20	27 ± 2	1.5 ± 0.25
8	¾ - 16	570 ± 25	48 ± 2	1.5 ± 0.25
10	7/8 - 14	1060 ± 50	90 ± 5	1.5 ± 0.25
12	1-1/16 - 12	1300 ± 50	110 ± 5	1.5 ± 0.25
14	1-3/16 - 12	1750 ± 75	145 ± 6	1.5 ± 0.25
16	1-5/16 - 12	1920 ± 25	160 ± 6	1.5 ± 0.25
20	1-5/8 - 12	2700 ± 150	225 ± 12	1.5 ± 0.25
24	1-7/8 - 12	3000 ± 150	250 ± 12	1.5 ± 0.25
32	2-1/2 - 12	3900 ± 200	325 ± 15	1.5 ± 0.25

Mnt-L-0003_D

RHINO

LIMITED WARRANTY

1. LIMITED WARRANTIES

- 1.01. Rhino warrants for one year from the purchase date to the original non-commercial, governmental, or municipal purchaser ("Purchaser") and warrants for six months to the original commercial or industrial purchaser ("Purchaser") that the goods purchased are free from defects in material or workmanship.
- 1.02. Manufacturer will replace for the Purchaser any part or parts found, upon examination at one of its factories, to be defective under normal use and service due to defects in material or workmanship.
- 1.03. This limited warranty does not apply to any part of the goods which has been subjected to improper or abnormal use, negligence, alteration, modification, or accident, damaged due to lack of maintenance or use of wrong fuel, oil, or lubricants, or which has served its normal life. This limited warranty does not apply to any part of any internal combustion engine, or expendable items such as blades, shields, guards, or pneumatic tires except as specifically found in your Operator's Manual.
- 1.04. Except as provided herein, no employee, agent, Dealer, or other person is authorized to give any warranties of any nature on behalf of Manufacturer.

2. REMEDIES AND PROCEDURES.

- 2.01. This limited warranty is not effective unless the Purchaser returns the Registration and Warranty Form to Manufacturer within 30 days of purchase.
- 2.02. Purchaser claims must be made in writing to the Authorized Dealer ("Dealer") from whom Purchaser purchased the goods or an approved Authorized Dealer ("Dealer") within 30 days after Purchaser learns of the facts on which the claim is based.
- 2.03. Purchaser is responsible for returning the goods in question to the Dealer.
- 2.04. If after examining the goods and/or parts in question, Manufacturer finds them to be defective under normal use and service due to defects in material or workmanship, Manufacturer will:
 - (a) Repair or replace the defective goods or part(s) or
 - (b) Reimburse Purchaser for the cost of the part(s) and reasonable labor charges (as determined by Manufacturer) if Purchaser paid for the repair and/or replacement prior to the final determination of applicability of the warranty by Manufacturer.

The choice of remedy shall belong to Manufacturer.

- 2.05. Purchaser is responsible for any labor charges exceeding a reasonable amount as determined by Manufacturer and for returning the goods to the Dealer, whether or not the claim is approved. Purchaser is responsible for the transportation cost for the goods or part(s) from the Dealer to the designated factory.

3. LIMITATION OF LIABILITY.

- 3.01. MANUFACTURER DISCLAIMS ANY EXPRESS (EXCEPT AS SET FORTH HEREIN) AND IMPLIED WARRANTIES WITH RESPECT TO THE GOODS INCLUDING, BUT NOT LIMITED TO, MERCHANTABILITY AND FITNESS FOR A PARTICULAR PURPOSE.
- 3.02. MANUFACTURER MAKES NO WARRANTY AS TO THE DESIGN, CAPABILITY, CAPACITY, OR SUITABILITY FOR USE OF THE GOODS.
- 3.03. EXCEPT AS PROVIDED HEREIN, MANUFACTURER SHALL HAVE NO LIABILITY OR RESPONSIBILITY TO PURCHASER OR ANY OTHER PERSON OR ENTITY WITH RESPECT TO ANY LIABILITY, LOSS, OR DAMAGE CAUSED OR ALLEGED TO BE CAUSED DIRECTLY OR INDIRECTLY BY THE GOODS INCLUDING, BUT NOT LIMITED TO, ANY INDIRECT, SPECIAL, CONSEQUENTIAL, OR INCIDENTAL DAMAGES RESULTING FROM THE USE OR OPERATION OF THE GOODS OR ANY BREACH OF THIS WARRANTY. NOT WITHSTANDING THE ABOVE LIMITATIONS AND WARRANTIES, MANUFACTURER'S LIABILITY HEREUNDER FOR DAMAGES INCURRED BY PURCHASER OR OTHERS SHALL NOT EXCEED THE PRICE OF THE GOODS.
- 3.04. NO ACTION ARISING OUT OF ANY CLAIMED BREACH OF THIS WARRANTY OR TRANSACTIONS UNDER THIS WARRANTY MAY BE BROUGHT MORE THAN TWO (2) YEARS AFTER THE CAUSE OF ACTION HAS OCCURRED.

4. MISCELLANEOUS.

- 4.01. Proper Venue for any lawsuits arising from or related to this limited warranty shall be only in Guadalupe County, Texas.
- 4.02. Manufacturer may waive compliance with any of the terms of this limited warranty, but no waiver of any terms shall be deemed to be a waiver of any other term.
- 4.03. If any provision of this limited warranty shall violate any applicable law and is held to be unenforceable, then the invalidity of such provision shall not invalidate any other provisions herein.
- 4.04. Applicable law may provide rights and benefits to purchaser in addition to those provided herein.

KEEP FOR YOUR RECORDS

ATTENTION: Purchaser should fill in the blanks below for his reference when buying repair parts and/or for proper machine identification when applying for warranty.

Rhino Implement Model _____ Serial Number _____

Date Purchased _____ Dealer _____

ATTENTION:

READ YOUR OPERATOR'S MANUAL

RHINO®

1020 S Sangamon Ave.

Gibson City, IL 60936

800-446-5158

Email: parts@servis-rhino.com





TO THE OWNER/OPERATOR/DEALER

To keep your implement running efficiently and safely, read your manual thoroughly and follow these directions and the Safety Messages in this Manual. The Table of Contents clearly identifies each section where you can easily find the information you need.

The OCCUPATIONAL SAFETY AND HEALTH ACT (1928.51 Subpart C) makes these minimum safety requirements of tractor operators:

REQUIRED OF THE OWNER:

1. Provide a Roll-Over-Protective Structure that meets the requirements of this Standard; and
2. Provide Seat belts that meet the requirements of this paragraph of this Standard and SAE J4C; and
3. Ensure that each employee uses such Seat belt while the tractor is moving; and
4. Ensure that each employee tightens the Seat belt sufficiently to confine the employee to the protected area provided by the ROPS

REQUIRED OF THE OPERATOR:

1. Securely fasten seat belt if the tractor has a ROPS.
2. Where possible, avoid operating the tractor near ditches, embankments, and holes.
3. Reduce speed when turning, crossing slopes, and on rough, slick, or muddy surfaces.
4. Stay off slopes too steep for safe operation.
5. Watch where you are going - especially at row ends, on roads, and around trees.
6. Do not permit others to ride.
7. Operate the tractor smoothly - no jerky turns, starts, or stops.
8. Hitch only to the drawbar and hitch points recommended by the tractor manufacturer.
9. When the tractor is stopped, set brakes securely and use park lock, if available.

Keep children away from danger all day, every day...

Equip tractors with rollover protection (ROPS) and keep all machinery guards in place...

Please work, drive, play and live each day with care and concern for your safety and that of your family and fellow citizens.



1598 -SOM-01/11
Printed U.S.A

**1598
LOADER**

P/N F-4257C